

MOLDINGS & WOODCARVINGS

Corbels, Crown Blocks, Capitals & Plynths



- Kitchens
- Doors
- Kitchen Accessories
- Hinges
- Drawer Slides
- Plywood Melamine
- Veneer Edgebanding
- Laminate
- Solid Surface
- Closets
- Furniture Hardware
- Pulls & Knobs
- Lighting
- Grommets
- Locks, Lock Systems
- Molding, Carvings
- Tools
- Adhesives Solvents Abrasives
- Chemicals Staples Screws

Carvings are subject to design enhancements



CRV5226
X-Large Imbricated Bracket Corbel
14" x 9" x 24"

CRV5228
Large Imbricated Corbel
8" x 7" x 16"

CRV5230
Large Imbricated Bracket Corbel
6" x 9" x 15"



CRV5130 (MA, CH)
Medium Corinthian Capital
1 3/4 x 8 x 8"
accepts up to 1 1/4 x 5 1/8"

CRV5133 (MA, CH)
Small Corinthian Capital
1 3/8 x 6 x 6"
accepts up to 7/8 x 4"

CRV5136 (MA, CH)
Petite Corinthian Capital
1 1/4" x 3 1/4" x 3 1/4"
*accepts up to 7/8 x 2
sold 2/ card*



CRV5253
Classic Corbel
7" x 3 1/2" x 14"

CRV5250
Classic Corbel
5" x 3" x 11"



CRV5256
Classic Corbel
3 1/2" x 7 1/2" x 12"

CRV5259
Classic Corbel
7" x 5 1/2" x 9"

Corbel dimensions are listed in order by width, depth and height



CRV5139
Large Ionic Capital
2 3/4" x 13" x 9H"
accepts up to 1 3/4 x 8"



CRV5095
Large Crown Block
5 1/2 x 5 1/2 x 12 1/8"
*Generally accepts crowns
5 1/4 - 7 1/2" wide*



CRV5140
Medium Ionic Capital
1 11/16" x 3 1/2" x 8"
accepts 1 1/4 x 5 1/8"

CRV5143
Small Ionic Capital
1 1/8" x 3" x 7"
accepts 7/8 x 4"

CRV5146
Petite Ionic Capital
1 3/16" x 2" x 3 1/2"
*accepts up to 7/8 x 2"
sold 2/card*



CRV5147
3 1/2" x 5 1/2" x 11 1/2"
accepts up to 1 3/4 x 8"



CRV5099 Small Crown Block
3 1/2 x 3 1/2 x 8 1/2"
*Generally accepts crowns
up to 5" wide*



CRV5129
Large Corinthian Capital
2 3/4" x 14 1/4" x 12H"
accepts up to 1 3/4 x 8"



CRV5148 (MA, CH)
2 1/2" x 3 1/2" x 7 1/4"
accepts up to 1 1/4 x 5 1/8"

CRV5149 (MA, CH)
1 7/8" x 3" x 6 1/4"
accepts up to 7/8 x 4"

CRV5150 (MA, CH)
1 3/8" x 1 1/2" x 2 7/8"
*accepts up to 7/8 x 2"
sold 2/card*

*All carvings available in Lindenwood
MA = Available in Maple, too.
CH = Available in Cherry, too.*

MOLDINGS & WOODCARVINGS



Corbels, Keystones & Modillion Blocks



CRV5091
Lion's Head
Corbel
8" x 6 1/2" x 26"



CRV5092
Large Fluted Corbel
9" x 7" x 24"

CRV5094 7" x 5
1/4" x 14"



CRV5097 (MA, CH)
Large Acanthus
Corbel
7 7/8" x 6" x 14 1/2"

CRV5098 (MA, CH)
Medium Acanthus
Corbel
5" x 4 1/2" x 12"



CRV5205
9" x 10" x 36 1/2"

CRV5210
Large Fluted
Acanthus Corbel
7 1/2" x 8 1/2" x 24"

*Carvings are
subject to design
enhancements*

*Corbel dimensions are listed
in order by width, depth and
height*



- Kitchens
- Doors
- Kitchen Accessories
- Hinges
- Drawer Slides
- Plywood Melamine
- Veneer Edgebanding
- Laminate



CRV5120 (MA, CH)
Large Acanthus
with Shell Corbel
6" x 2 1/2" x 14"

CRV5121 (MA, CH)
Medium Acanthus
with Shell Corbel
4 1/2" x 1 3/4" x 10"



CRV5110 (MA, CH)
Large Grapevine
Tassel Corbel
5 1/2" x 7" x 15"

CRV5112 (MA, CH)
Medium Grapevine
Tassel Corbel
4 3/4" x 5 1/4" x 10"



CRV5216
X-Large Bellflower Corbel
7 1/2" x 11 1/2" x 24"

CRV5218
Large Bellflower
Corbel
6" x 8 1/4" x 14 1/2"

CRV5220
Large Bellflower
Bracket Corbel
4" x 9 1/4" x 14 1/2"



CRV5105 (MA, CH)
Classic Corbel
5 1/4" x 4 1/2" x 12 1/2"

CRV5109
Classic Corbel
4 1/2" x 4" x 9 3/4"

CRV5107 (MA, CH)
Classic Corbel
3 3/4" x 3 1/2" x 6 1/2"



CRV5236
Large Fluted Corbel
9 1/4" x 6" x 16 1/2"

CRV5238
Medium
Fluted Corbel
7 3/4" x 3" x 14"

CRV5240
Small Fluted Corbel
5 1/2" x 2 1/2" x 10"

- Solid Surface
- Closets
- Furniture Hardware
- Pulls & Knobs
- Lighting
- Grommets
- Locks, Lock Systems



CRV5100 (MA, CH)
Acanthus Grapevine Corbel
3 1/2" x 8" x 13"



CRV5123
Modillion Block
1 3/4" x 1 1/2" x 2 3/4"
sold 4/card



CRV5127
2 1/2" x 8" x 9 1/2"



CRV5125 (MA, CH)
Petite Acanthus Corbel
3" x 1 3/4" x 4 1/4"
sold 2/card



CRV5126 (MA, CH)
Petite Corbel
3" x 1 3/4" x 4 1/4"
sold 2/card

*All carvings available in Lindenwood
MA = Available in Maple
CH = Available in Cherry*

- Tools
- Adhesives Solvents Abrasives
- Chemicals Staples Screws

MOLDINGS & WOODCARVINGS

Centers, Swags, Scrolls, Drops & Corners



Authentic HAND-CARVED

Kitchens

Doors

Kitchen Accessories

Hinges

Drawer Slides

Plywood Melamine

Veneer Edgebanding

Laminate

Solid Surface

Closets

Furniture Hardware

Pulls & Knobs

Lighting

Grommets

Locks, Lock Systems

Molding, Carvings

Tools

Adhesives Solvents Abrasives

Chemicals Staples Screws



CRV5077
Shell &
Floral Drop
5/8" x 4 1/2" x 10"



CRV5030
Flower Center
With Clusters
13/16" x 3 1/2" x 15 3/4"



CRV5038
(MA, CH)
Grapevine
Medallion
1" x 6" x 14 1/4"



CRV5020 (MA, CH) Large Cluster with Scrolls - 7/8" x 7" x 36"

CRV5022 (MA, CH) Medium Cluster with Scrolls - 3/4" x 4 1/2" x 24"



CRV5040 Large Shell with Scrolls - 7/8" x 7" x 36"

CRV5043 Medium Shell with Scrolls - 3/4" x 5" x 24"

CRV5044 Small Shell with Scrolls - 5/8" x 4" x 12"



CRV5087
Large Floral Drop
1" x 5 1/2" x 14"



CRV5089
Small Floral Drop
1" x 5 1/2" x 8"



CRV5053 Laurel
Center
3/4" x 8 1/4" x 8"



CRV5046 (MA, CH) Large Acanthus with Scrolls - 7/8" x 7 1/2" x 36"

CRV5048 (MA, CH) Medium Acanthus with Scrolls - 3/4" x 6" x 24"

CRV5049 (MA, CH) Small Acanthus with Scrolls - 5/8" x 4" x 12"



CRV5058
Flower Basket
1" x 10 1/2" x 10"



CRV5060
Large Urn
3/4" x 6 1/2" x 11"



CRV5055
Shell Center
1" x 8" x 7 1/2"



CRV5063
Small Urn
3/4" x 6 1/2" x
3 1/4"



CRV5050 Medium Rosette with Scrolls
3/4" x 5 1/2" x 24"

CRV5051 Small Rosette with Scrolls
5/8" x 3 1/4" x 12"

DRAWER PULLS & KNOBS



CRV5032 (MA, CH)
Large Pull
1 1/2" x 3 3/4" x 12"



CRV5034 (MA, CH)
Small Pull
1 1/4" x 1 7/8" x 4 1/2"
sold 2/card



CRV5036 (MA, CH)
Vineyard Knobs
1 5/16" x 1 1/2" Dia
sold 4/card



CRV5073
Large Plume Corner
13/16" x 12" x 12"

CRV5074
Medium Plume Corner
13/16" x 8" x 8"

CRV5075 (MA, CH)
Small Plume Corner
5/8" x 4" x 4"
sold 2/card



CRV5071 Rose Swag
1 3/16" x 6 5/16" x 14 3/8"



CRV5072 Laurel Swag
3/4" x 5" x 12"



CRV5069 Large Floral Swag
1 1/2" x 6" x 16"

CRV5070 Small Floral Swag
1 1/2" x 4 1/2" x 12"



CRV5024 (MA, CH) Medium Vineyard Scrolls
13/16" x 4" x 9" sold L and R pair per card

CRV5026 Small Vineyard Scrolls
5/8" x 2 1/2" x 6" sold L and R pair per card

All carvings available in
Lindenwood
MA = Available in Maple
CH = Available in Cherry



MOLDINGS & WOODCARVINGS



Centers, Scrolls, Drops, Corners, Rosettes & More



CRV5065 Large Scrolls, left and right - 13/16" x 4 1/2" x 16" sold L and R pair per card



CRV5066 (MA, CH) Medium Scrolls 13/16" x 3 1/2" x 12" sold L and R pair per card



CRV5067 (MA, CH) Large Floral Scrolls 13/16" x 5 1/2" x 11" sold L and R pair per card



CRV5068 (MA, CH) Medium Floral Scrolls 3/4" x 3 1/2" x 7" - sold L and R pair per card



CRV5191 Med Acanthus Center 1/2" x 1 1/4" x 4 3/4" sold 4/card



CRV5090 Petite Square 3/8" x 1 7/8" x 1 7/8" sold 4/card



CRV5096 Med Round Rosette 3/8" x 3" sold 2/card



CRV5193 ~ Medium Star 5/8" x 4" sold 4/card

CRV5194 ~ Small Star 1/2" x 2 1/2" sold 4/card

All carvings available in Lindenwood
MA = Available in Maple
CH = Available in Cherry



CRV5197 Medium Star Rosette 1 3/8" x 5 1/2" (Star is 4") Rosette accepts 13/16 casings sold 2/card

CRV5198 Small Star Rosette 1 3/8" x 3 1/2" (Star is 2 1/2") Rosette accepts 13/16 casings sold 2/card



CRV5166 X-Lg Round Rosette 7/8" x 7"

CRV5168 (MA, CH) Lg Round Rosette 3/4" x 5" sold 2/card



CRV5179 (MA, CH) Sm Oval Rosette 5/8" x 2 3/4" x 4" sold 2/card

CRV5178 (MA, CH) Med Oval Rosette 3/4" x 3 1/2" x 5" sold 2/card

CRV5177 Lg Oval Rosette 7/8" x 4 1/2" x 6 1/2"



CRV5181 Med Acanthus Leaf 1/2" x 3 7/8" x 3 7/8" sold 4/card

CRV5183 Sm Acanthus Leaf 3/8" x 2 5/8" x 2 5/8" sold 4/card



CRV5093 Petite Round Rosette 3/8" x 1 7/8" sold 4/card



CRV5185 Med Fleur de lis 1/2" x 3 1/2" x 4 1/8" sold 4/card

CRV5187 Sm Fleur de lis 3/8" x 2 1/4" x 2 3/4" sold 4/card



CRV5078 Floral Acanthus Scrolls 7/8" x 14" x 14" sold L and R per card

CRV5079 (MA, CH) Clipped Scroll Corners 5/8" x 4 1/4" x 4 1/4" sold 4/card 2 left - 2 right



CRV5195 Lion's Head Rosette 1 1/2" x 6 1/2" x 7"



CRV5028 Grape Cluster 3/4" x 5(H)" x 6 1/4" sold L and R pair per card



CRV5160 (MA, CH) Lg Square Rosette 5/8" x 5" x 5" sold 2/card

CRV5164 (MA, CH) Med Square Rosette 3/8" x 3 1/2" x 3 1/2" sold 2/card



CRV5172 Med Rectangular Rosette 3/4" x 3 1/2" x 5 1/2" sold 2/card

CRV5173 Sm Rectangular Rosette 5/8" x 2 3/4" x 4 1/2" sold 2/card

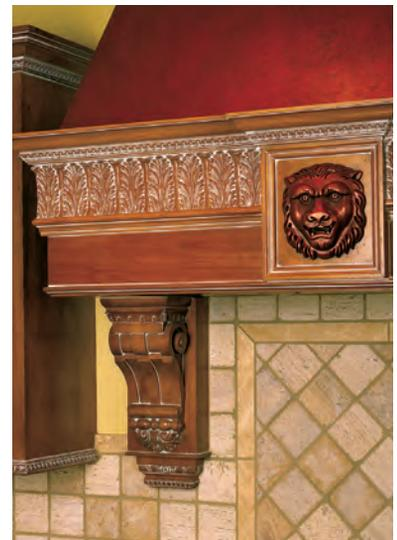

Kitchens

Doors

Kitchen Accessories

Hinges

Drawer Slides

Plywood Melamine

Veneer Edgebanding

Laminate

Solid Surface

Closets

Furniture Hardware

Pulls & Knobs

Lighting

Grommets

Locks, Lock Systems

Molding, Carvings

Tools

Adhesives Solvents Abrasives

Chemicals Staples Screws

Most of the merchandise in this catalog is available in all Hardware Imagination-Tech locations. If your selection isn't available at the store nearest you, we'll gladly order it from one of the other stores or through special order.

MOLDINGS & WOODCARVINGS

Range Hoods

Maple & Cherry



Kitchens

Doors

Kitchen Accessories

Hinges

Drawer Slides

Plywood Melamine

Veneer Edgebanding

Laminate

Solid Surface

Closets

Furniture Hardware

Pulls & Knobs

Lighting

Grommets

Locks, Lock Systems

Molding, Carvings

Tools

Adhesives Solvents Abrasives

Chemicals Staples Screws

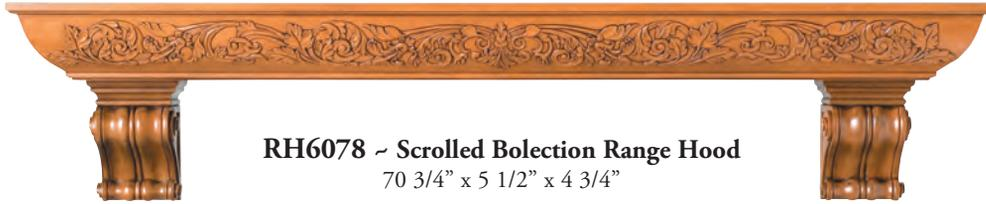

RH6078 ~ Scrolled Bolection Range Hood
70 3/4" x 5 1/2" x 4 3/4"

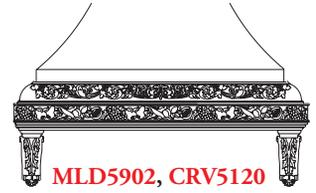

MLD5902, CRV5120



RH6080, CRV5097

- Endless applications include range hoods, mantels, crown moulding, valances and window treatments.
- The range hood comes packaged as 9 pieces: 3 carved radius pieces, a front, a left and a right hand side, and the solid stock with profiled edges to go with it. Can be modified to fit jobsite conditions.
- Corner edges of the pieces will need to be mitered and assembly is required.
- Depth: 34 3/4"

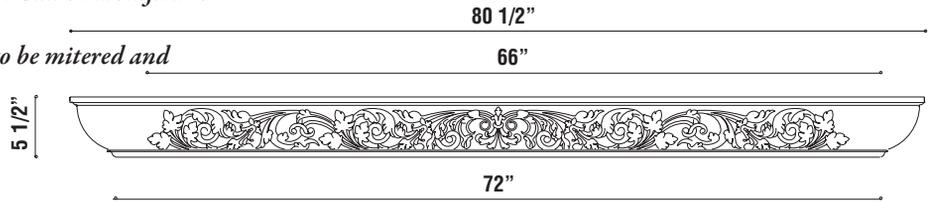

RH6084 ~ Palmette Range Hood
62 1/8" x 12" x 1 1/4"

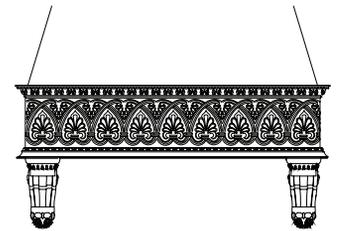

MLD5842, MLD5976, CRV5092

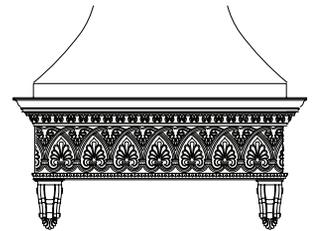

MLD5868, MLD5840, MLD5980, CRV5240

- Applications may include range hoods, mantels, valances and window treatments.
- The range hood comes packaged as 3 pieces: a front, a left and a right hand side, which can be modified to fit jobsite conditions.
- Corner edges of the pieces will need to be mitered and assembly is required.
- Depth: 33"

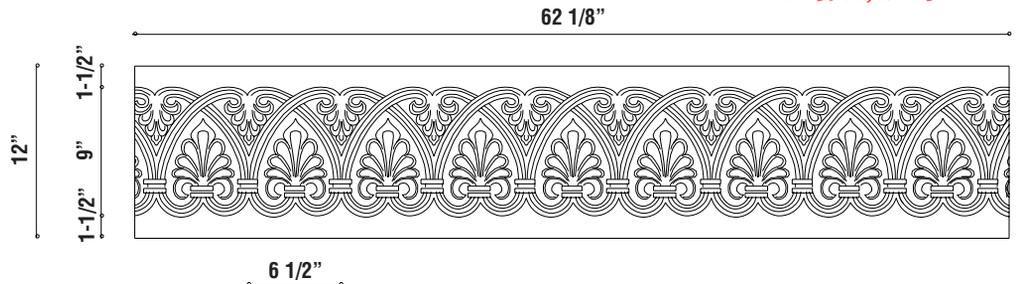

MOLDINGS & WOODCARVINGS



Maple & Cherry

Range Hoods



RH6078, MLD5848, CRV5620,
CRV5614, CRV5228



RH6075 ~ Tuscan Country Range Hood
65" x 15 1/2" x 1 1/4"

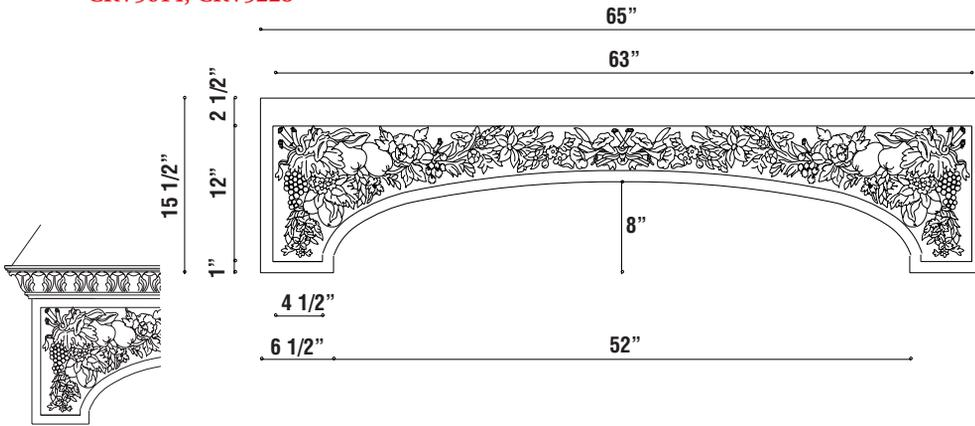

MLD5840

- Applications include range hoods, mantels, valances and window treatments.
- It comes packaged as 3 pieces: a front, a left and a right hand side, which can be modified to fit any jobsite conditions.
- Shorten or lengthen this item with acenter key.
- Corner edges of the pieces will need to be mitered and assembly is required.
- Depth: 30"



MLD5842, MLD5982,
MLD5980, CRV5097



RH6082 ~ Rinceau Scrolls with Floral Basket Range Hood
72" x 12" x 1 1/4"

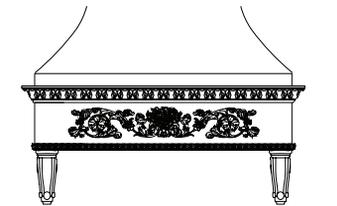

MLD5840, MLD5942, CRV5105

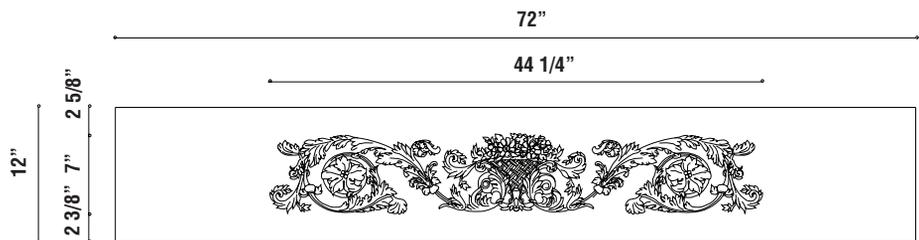

- Applications may include range hoods, mantels, valances and window treatments.
- Range hood comes packaged as 3 pieces: a front, a left and right hand side, which can be modified to fit jobsite conditions.
- Corner edges will need to be mitered and assembly required.
- Depth: 30"

Kitchens

Doors

Kitchen
Accessories

Hinges

Drawer
Slides

Plywood
Melamine

Veneer
Edgebanding

Laminate

Solid
Surface

Closets

Furniture
Hardware

Pulls
&
Knobs

Lighting

Grommets

Locks,
Lock
Systems

Molding,
Carvings

Tools

Adhesives
Solvents
Abrasives

Chemicals
Staples
Screws

MOLDINGS & WOODCARVINGS

Mantles



Kitchens

Doors

Kitchen Accessories

Hinges

Drawer Slides

Plywood Melamine

Veneer Edgebanding

Laminate

Solid Surface

Closets

Furniture Hardware

Pulls & Knobs

Lighting

Grommets

Locks, Lock Systems

Molding, Carvings

Tools

Adhesives Solvents Abrasives

Chemicals Staples Screws



MAN9012LW
Floral Swag with Urn
 Full Surround
 87" w x 58 3/4" h x 12" d
 Opening: 52" w x 40" h
 Shelf - 87" w x 12" d
 Mantel Width at Base - 70"
 Depth of Legs at Base - 3 1/2"
 Mantel Width at Legs - 69 1/4"
 Mantel Width at Corbels - 78 1/4"
 Carved Center Panel - 54 1/2" x 9 1/2"



MAN9030LW **Urn with Fluting**
 72" w x 11" h x 8" d
 bottom depth 5"



MAN9033LW **Center with Rosettes**
 72 1/2" w x 13" h x 8" d
 bottom depth 5"



MAN9015LW
Rinceau Scrolls with Floral Basket
 Full Surround
 81" w x 57" h x 8" d
 Opening: 52" w x 40" h
 Shelf - 81" w x 8" d
 Mantel Width at Base - 73"
 Depth of Legs at Base - 5 1/2"

All Mantels are handcarved in Lindenwood, installation-ready in 3-4 pieces (hardware included), and in-stock ready for shipment. Lindenwood is prepared to finish; stain or paint.

MOLDINGS & WOODCARVINGS



Mantles

- Kitchens
- Doors
- Kitchen Accessories
- Hinges
- Drawer Slides
- Plywood Melamine
- Veneer Edgebanding
- Laminate
- Solid Surface
- Closets
- Furniture Hardware
- Pulls & Knobs
- Lighting
- Grommets
- Locks, Lock Systems
- Molding, Carvings
- Tools
- Adhesives Solvents Abrasives
- Chemicals Staples Screws



MAN9018LW
Fluting with Bellflower Drops
 Full Surround
 76 3/4" w x 53 1/2" h x 9 1/4" d
 Opening: 52" w x 40" h
 Shelf - 76 3/4" w x 9 1/4" d
 Mantel Width at Base - 72 5/8"
 Mantel Depth at Legs - 7 5/8"
 Center Panel - 19 1/2" w x 6 7/8" h
 Leg Width - 10 1/8"



MAN9039LW
Rinceau Scroll with Flower Basket
 72" w x 14" h x 8" d
 bottom depth 4 1/2"

MAN9042LW
Rinceau Scroll with Flower Basket
 60" w x 12 1/2" h x 8" d
 bottom depth 4 1/2"



MAN9035LW
Embraced Palmette
 70" w x 12" h x 8" d
 bottom depth 5 3/4"

MAN9036LW
Embraced Palmette
 60" w x 12" h x 8" d
 bottom depth 5 3/4"



MAN9021LW
Shell with Country Flowers
 Full Surround
 72" w x 52" h x 9 3/4" d
 Opening: 52" w x 40" h
 Shelf - 68" w x 9 3/4" d
 Carved Center Panel - 36" w

MOLDINGS & WOODCARVINGS



Columns – Full Rounds & Splits

Kitchens

Doors

Kitchen Accessories

Hinges

Drawer Slides

Plywood Melamine

Veneer Edgebanding

Laminate

Solid Surface

Closets

Furniture Hardware

Pulls & Knobs

Lighting

Grommets

Locks, Lock Systems

Molding, Carvings

Tools

Adhesives Solvents Abrasives

Chemicals Staples Screws

Greco Roman

Maple & Cherry – Available Whole & Split

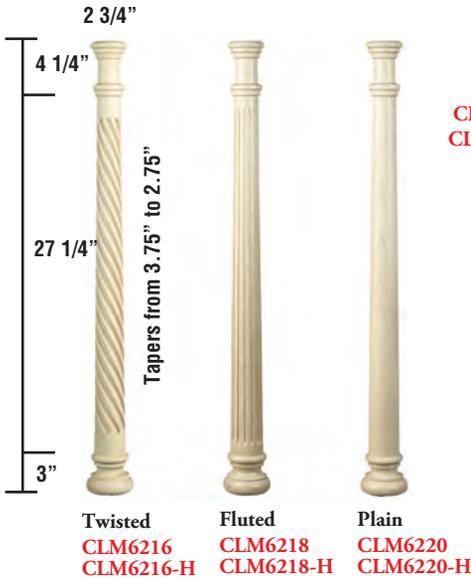

All Columns sold as whole and splits.

EXAMPLE:

CLM6216 - whole column sold 1/pkg.
CLM6216-H - split column sold 2/pkg.

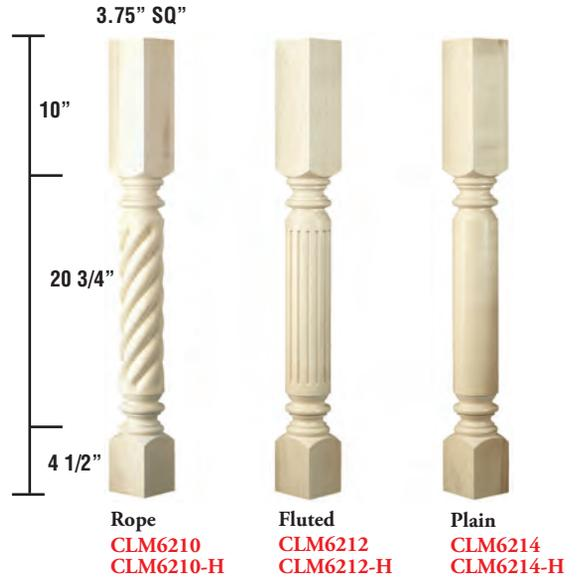

English Estate

Maple & Cherry – Available Whole & Split

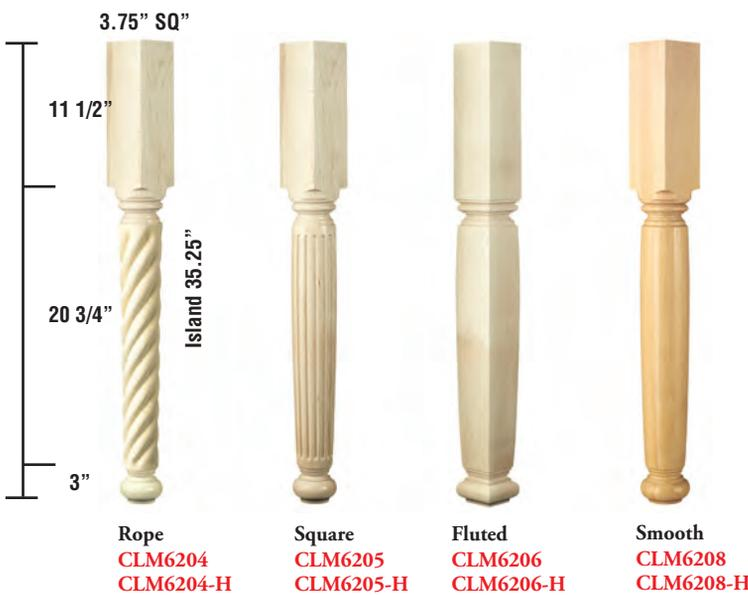

ALL Columns are trimmable.

Catalog dimensions rounded to the nearest 1/8".

Country French

Maple & Cherry
Available Whole & Split

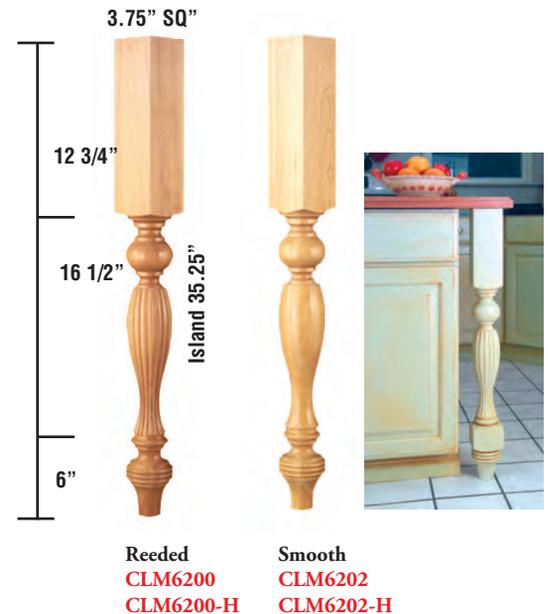

MOLDINGS & WOODCARVINGS



End Blocks, Splicers, Plyths and Feet

Products on pages ??-?? are designed so that all large items fit each other, medium fits medium and small fits small.

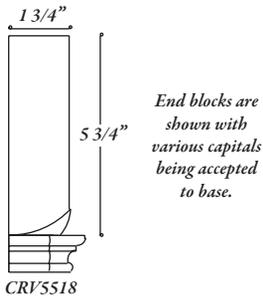

End blocks are shown with various capitals being accepted to base.

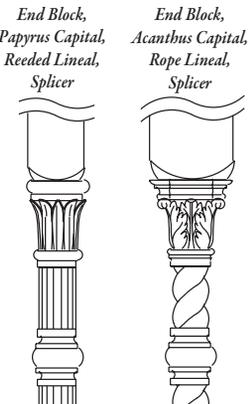
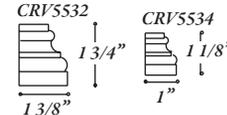
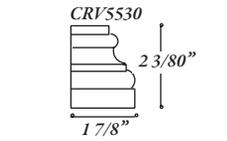
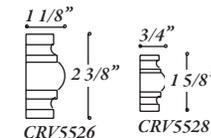
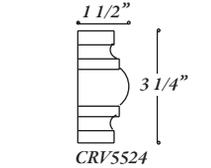
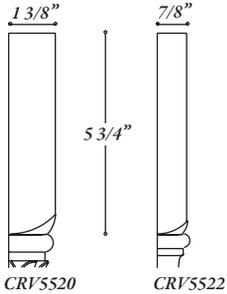

CRV5518
Large End Block
 3 1/2" x 5 3/4" x 1 3/4"
 accepts up to 3 1/2" x 1 3/4"
 Accepts Large Capitals
 sold 2/pkg.

CRV5520
Medium End Block
 2 5/8" x 5 3/4" x 1 3/8"
 accepts up to 2 5/8" x 1 3/8"
 Accepts Medium Capitals
 sold 2/pkg.

CRV5522
Small End Block
 1 3/4" x 5 3/4" x 7/8"
 accepts up to 1 3/4" x 7/8"
 Accepts Small Capitals
 sold 2/pkg.

Slight variations occur during the hand carving process.



CRV5524
Large Splicer
 3" x 3 1/4" x 1 1/2"
 accepts up to 2" x 1"
 sold 2/pkg.

CRV5526
Medium Splicer
 2 1/4" x 2 3/8" x 1 1/8"
 accepts up to 1 1/2" x 3/4"
 sold 2/pkg.

CRV5528
Small Splicer
 1 1/2" x 1 5/8" x 3/4"
 accepts up to 1" x 1/2"
 sold 2/pkg.



CRV5530
Large Traditional Plyth
 3 3/4" x 2 3/8" x 1 7/8"
 accepts up to 2" x 1"
 sold 2/pkg.

CRV5532
Medium Traditional Plyth
 2 3/4" x 1 3/4" x 1 3/8"
 accepts up to 1 1/2" x 1"
 sold 2/pkg.

CRV5534
Small Traditional Plyth
 1 7/8" x 1 1/8" x 1"
 accepts up to 1" x 1/2"
 sold 2/pkg.



FT6270
Pedestal Corner Foot
 8 1/4" each side x 4" x 1 5/8"



FT6274
Center Panel
 16" x 2 1/2" x 1"



FT6272
Pedestal Foot
 8 1/4" x 4" x 1 5/8"
 sold left and right



FT6294 FT6294-H
Heavy Fluted Bun Foot
 4 7/8" dia. x 5 3/8"



FT6293 FT6293-H
Traditional Bun Foot
 3 3/16" dia. x 4 1/2"



FT6290 FT6290-H
Tall Fluted Foot
 3 3/4" dia. x 8"



FT6295 FT6295-H
Heavy Traditional Bun Foot
 4 7/8" dia. x 5 3/8"



FT6292 FT6292-H
Fluted Bun Foot
 3 3/16" dia. x 4 1/2"



FT6291 FT6291-H
Tall Traditional Foot
 3 3/4" dia. x 8"

Dimensions are listed in order by width at widest point, overall height and depth.

All Turned Feet sold as whole and splits.

EXAMPLE:
FT6292 - whole foot sold 1/pkg.
FT6292-H - split foot sold 2/pkg.

- Kitchens
- Doors
- Kitchen Accessories
- Hinges
- Drawer Slides
- Plywood Melamine
- Veneer Edgebanding
- Laminate
- Solid Surface
- Closets
- Furniture Hardware
- Pulls & Knobs
- Lighting
- Grommets
- Locks, Lock Systems
- Molding, Carvings
- Tools
- Adhesives Solvents Abrasives
- Chemicals Staples Screws

Corner Posts and Feet



Kitchens

Doors

Kitchen Accessories

Hinges

Drawer Slides

Plywood Melamine

Veneer Edgebanding

Laminate

Solid Surface

Closets

Furniture Hardware

Pulls & Knobs

Lighting

Grommets

Locks, Lock Systems

Molding, Carvings

Tools

Adhesives Solvents Abrasives

Chemicals Staples Screws



CP6240
42" Filigree Corner Post
2 3/4" sq. x 42"

CP6242
36" Filigree Corner Post
2 3/4" sq. x 36"

CP6244
30" Filigree Corner Post
2 3/4" sq. x 30"



CP6246
42" Traditional Corner Post
2 3/4" sq. x 42"

CP6248
36" Traditional Corner Post
2 3/4" sq. x 36"

CP6250
30" Traditional Corner Post
2 3/4" sq. x 30"

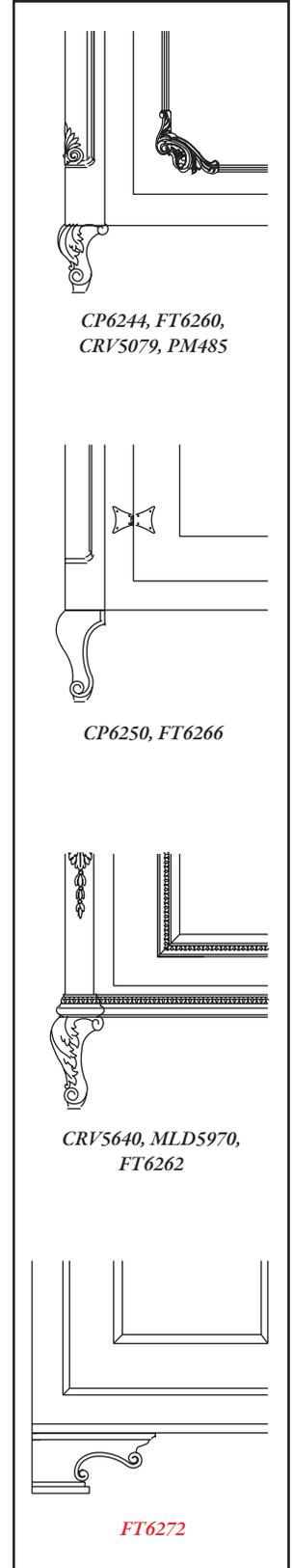
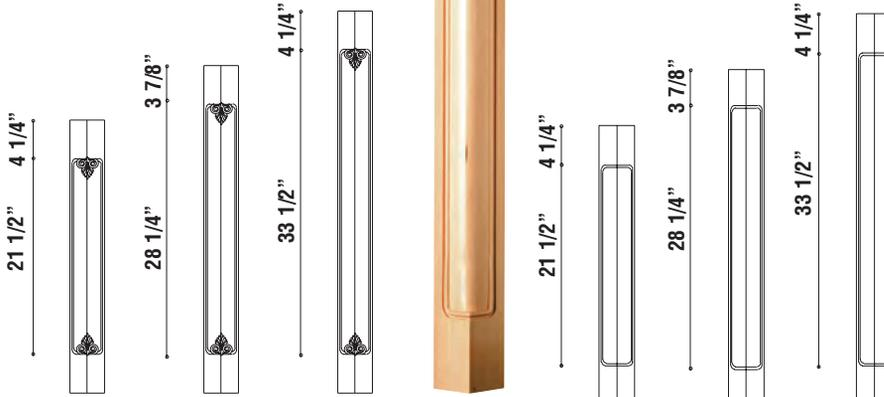

CP6244, FT6260,
CRV5079, PM485

CP6250, FT6266

CRV5640, MLD5970,
FT6262

FT6272



FT6260
Acanthus Corner Foot
3 3/8" x 4 1/2" x 2 3/4"



FT6262
Tall Acanthus Corner Foot
3 5/8" x 6" x 2 3/4"



FT6264
Traditional Corner Foot
3 1/4" x 4 1/2" x 2 3/4"



FT6266
Tall Traditional Corner Foot
3 3/8" x 6" x 2 3/4"



MOLDINGS & WOODCARVINGS



Mouldings - Special Order

MLD5842 Medium Acanthus Crown
 3 1/2" x 13/16" x 96" - Repeats 2 1/2"

MLD5844 Small Acanthus Crown
 2 1/2" x 13/16" x 96" - Repeats 1 3/4"



MLD5848 Large Egg and Dart Crown
 4 3/4" x 13/16" x 96" - Repeats 1 3/4"

Repeats and carvings may vary slightly due to the nature of the hand carving process.



MLD5864 with insert MLD6000



MLD5866 with insert MLD6002



MLD5869 Traditional Crown
 2 1/2" x 11/16" x 96"



MLD5840 Large Acanthus Crown
 4 3/4" x 13/16" x 96" - Repeats 3 1/2"



MLD5846 Medium Egg and Dart Crown
 3" x 13/16" x 96" - Repeats 2 3/4"



MLD5860 Medium Fluted Crown
 3 1/2" x 13/16" x 96" - Repeats 2"



MLD5864 Large Traditional Cove Crown
 3 1/2" x 13/16" x 96"
 Accepts insert panel moulds



MLD5866 Medium Traditional Cove Crown
 2 1/2" x 13/16" x 96"
 Accepts insert panel moulds



MLD5868 Traditional Crown
 3 1/2" x 13/16" x 96"

Kitchens

Doors

Kitchen Accessories

Hinges

Drawer Slides

Plywood Melamine

Veneer Edgebanding

Laminate

Solid Surface

Closets

Furniture Hardware

Pulls & Knobs

Lighting

Grommets

Locks, Lock Systems

Molding, Carvings

Tools

Adhesives Solvents Abrasives

Chemicals Staples Screws

MOLDINGS & WOODCARVINGS

Plywood Quarter Rounds

Kitchens

Doors

Kitchen Accessories

Hinges

Drawer Slides

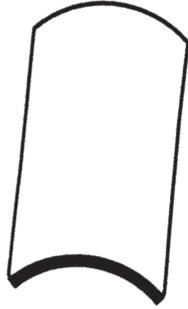

ORDER NUMBER	RADIUS	LENGTH	THICKNESS
51-930	3"	96"	5/8"
51-932	3"	96"	3/4"
51-808	4"	86"	5/8"
51-812	4"	86"	3/4"
31-108	5"	86"	3/4"
51-818	6"	86"	3/4"
31-106	7"	96"	5/8"
51-820	12"	60"	5/8"
51-822	24"	36"	5/8"

Plywood Melamine

Plywood Half Rounds

Veneer Edgbanding

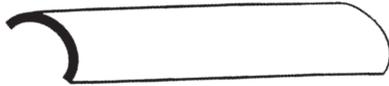

Laminate

ORDER NUMBER	DIAMETER	LENGTH	THICKNESS
51-934	4"	96"	5/8"
51-830	6"	96"	5/8"
51-832	8"	96"	5/8"
51-834	10"	96"	5/8"
51-836	12"	96"	5/8"
51-844	24"	50"	5/8"

Solid Surface

Closets

Furniture Hardware

Continuous Aluminum & Wood Pulls

ORDER NUMBERS

Pol. aluminum Pull**31-102**

1-3/8" High Back
12' Lengths

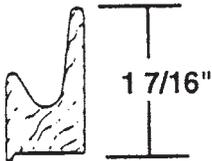
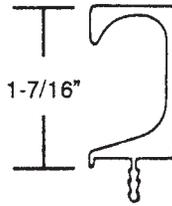

UNFINISHED RED OAK
J-Pull no spline....**31-248**

1-3/8" High Back
Boxed Approx. 100' LF

UNFINISHED RED OAK
C-Pull w/spline..... **31-242**
C-Pull no spline **31-244**

Sold in Box Quantity Only

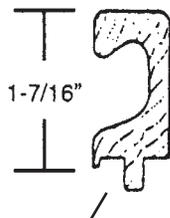

Spline

Half Round Moulding

Door and Top Edging

12' Lengths

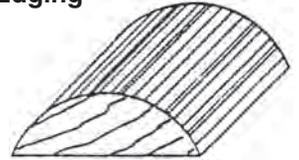

FINISHES

Unfinished Red Oak 1-9/16" **31-194**
Maple 1-9/16" **51-538**
Cherry 1-9/16" **51-548**

Counter Top Moulding

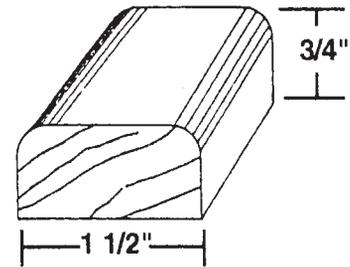

FINISHES

Unfinished Red Oak **31-192**

5/8" Plastic "U" Channel

ORDER NUMBER
31-134

8' Lengths
100 Pieces per Box

