

## High Power Display LED Lights

- Available 9" and 19"
- Cree LED
- Slim Design
- Ideal For Narrow Spaces
- Easy To Install
- Color Temperature Cool White
- 4000K ~ 5000K



## Radiance



**HEIGHT  
ADJUSTABLE**

Brilliant Modern Design, Ideal For Jewelry Displays, Showcases, Store Fixtures, Museums And Retail Applications. Low Energy Consumption, Rated At 40,000 Hours, Easily Adjustable For Custom Installation

### RADIANCE 3 WATT HIGH POWER LED

MODEL NUMBER	COLOR FINISH	HEIGHT	NUMBER OF LED's	LUMENS	EFFICACY LUMEN / WATT	INPUT CONSTANT CURRENT	TOTAL WATTS	LIFE HOURS	BEAM ANGLE	CURRENT (A)	OPERATING TEMPERATURE	CRI
H5.12111-010	WHITE	9"	3	300 lm	100 lm	350mA	3W	40,000	60°	.35mA	25° C	85
H5.12111-014	BLACK	9"	3	300 lm	100 lm	350mA	3W	40,000	60°	.35mA	25° C	85
H5.12111-074	SATIN ALUMINUM	9"	3	300 lm	100 lm	350mA	3W	40,000	60°	.35mA	25° C	85
H5.12112-010	WHITE	19"	3	300 lm	100 lm	350mA	3W	40,000	60°	.35mA	25° C	85
H5.12112-014	BLACK	19"	3	300 lm	100 lm	350mA	3W	40,000	60°	.35mA	25° C	85
H5.12112-074	SATIN ALUMINUM	19"	3	300 lm	100 lm	350mA	3W	40,000	60°	.35mA	25° C	85

**\* NOTE: Please Connect All Components Before Plugging into Electrical Outlet \***

**\* See Specifications and Accessories on Next Page \***

## High Power Display LED Lights

- Available 9" and 19"
- Cree LED
- Slim Design
- Ideal For Narrow Spaces
- Easy To Install
- Color Temperature Cool White
- 4000K ~ 5000K

### Detail 1

Using Allen Wrench, the head can be adjusted.

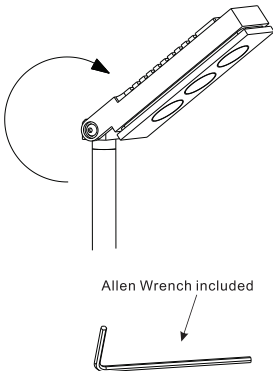

Allen Wrench included

### Detail 2

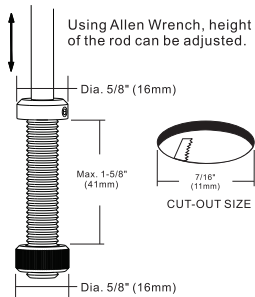

Using Allen Wrench, height of the rod can be adjusted.

Dia. 5/8" (16mm)

Max. 1-5/8" (41mm)

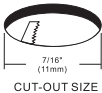

7/16" (11mm)  
CUT-OUT SIZE

Dia. 5/8" (16mm)

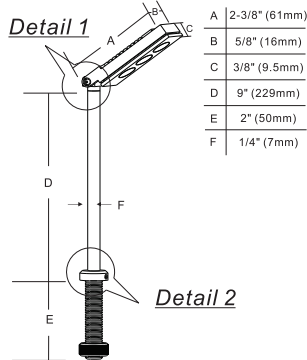

9" RADIANCE 3 WATT HIGH POWER LED  
Item No. H5.12111

### SPECIFICATION:

- Input: 350 mA DC
- Power: 3 Watts
- Beam Angle: 60°

### CAUTION:

- Use Constant Current DC power supply only. Out-put current of the power supply should not be over 350mA.
- Check polarity of the power supply before linking with the light. Polarity of the light is 
- These light should be linked to each other in series. Then you can turn on the power supply.
- Do not turn on the power supply before you have connected all the light together. This would result in burning out the LED bulbs.

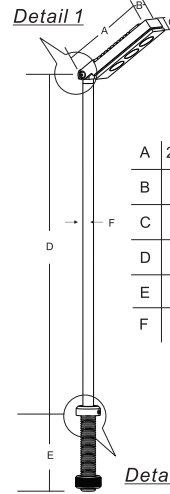

19" RADIANCE 3 WATT HIGH POWER LED  
Item No. H5.12112

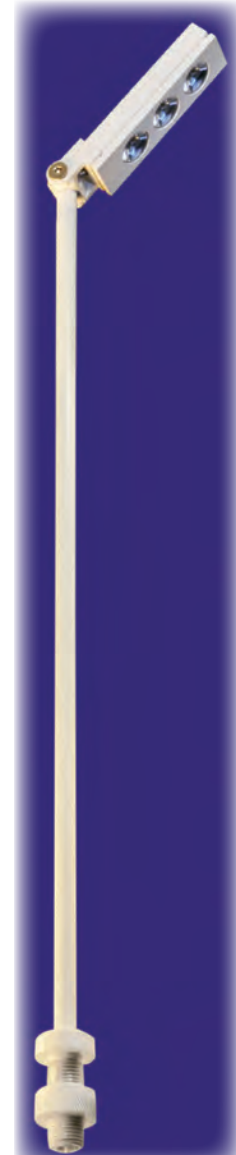

Kitchens

Doors

Kitchen Accessories

Hinges

Drawer Slides

Plywood Melamine

Veneer Edgebanding

Laminate

Solid Surface

Closets

Furniture Hardware

Pulls & Knobs

Lighting

Grommets

Locks, Lock Systems

Molding, Carvings

Tools

Adhesives Solvents Abrasives

Chemicals Staples Screws

### REQUIRED COMPONENTS



MALE / MALE CONNECTOR  
Item Number 41-506

POWER SUPPLY  
Item Number 41-514  
Input: CV 100~240v  
Output: 300mA Constant Current, 30 V Max  
Connect up to 3 Lights

### OPTIONAL ACCESSORIES



### EXTENSION

ORDER #	SIZE
41-500	24"
41-502	36"
41-504	84"

# Lighting

## High Power Display LED Lights

- Available 9" and 19"
- Cree LED
- Slim Design
- Ideal For Narrow Spaces
- Easy To Install
- Color Temperature Cool White
- 4000K ~ 5000K



Brilliant Modern Design, Ideal For Jewelry Displays, Showcases, Store Fixtures, Museums And Retail Applications. Low Energy Consumption, Rated At 40,000 Hours, Easily Adjustable For Custom Installation

### Summer



**HEIGHT  
ADJUSTABLE**

### SUMMER 6 WATTS HIGH POWER LED

	MODEL NUMBER	COLOR FINISH	HEIGHT	NUMBER OF LED'S	LUMENS	EFFICACY LUMEN / WATT	INPUT CONSTANT CURRENT	TOTAL WATTS	LIFE HOURS	BEAM ANGLE	CURRENT (A)	OPERATING TEMPERATURE	CRI
Locks, Lock Systems	H5.12113-010	WHITE	9"	2	300 lm	50 lm	500mA	6W	40,000	100°	.5mA	25° C	85
Molding, Carvings	H5.12113-014	BLACK	9"	2	300 lm	50 lm	500mA	6W	40,000	100°	.5mA	25° C	85
	H5.12113-074	SATIN ALUMINUM	9"	2	300 lm	50 lm	500mA	6W	40,000	100°	.5mA	25° C	85
Tools	H5.12114-010	WHITE	19"	2	300 lm	50 lm	500mA	6W	40,000	100°	.5mA	25° C	85
	H5.12114-014	BLACK	19"	2	300 lm	50 lm	500mA	6W	40,000	100°	.5mA	25° C	85
Adhesives Solvents Abrasives	H5.12114-074	SATIN ALUMINUM	19"	2	300 lm	50 lm	500mA	6W	40,000	100°	.5mA	25° C	85

### LINKABLE POWER SUPPLY OPTIONS

Fixture			H5.12113	H5.12114
H5.12026	POWER SUPPLY	500mA Constant Current 18 ~ 36V DC	Use with:	3 - 5 Lights
H5.12027	POWER SUPPLY	500mA Constant Current 8 ~ 24V DC	Use with:	2 Lights

**\* NOTE: Please Connect All Components Before Plugging into Electrical Outlet \***

**\* See Specifications and Accessories on Next Page \***

# Lighting

## High Power Display LED Lights

- Available 9" and 19"
- Cree LED
- Slim Design
- Ideal For Narrow Spaces
- Easy To Install
- Color Temperature Cool White
- 4000K ~ 5000K

### Detail 1

Using Allen Wrench, the head can be adjusted.

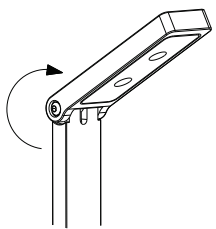

Allen Wrench included

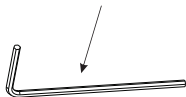

### Detail 2

Using Allen Wrench, height of the rod can be adjusted.

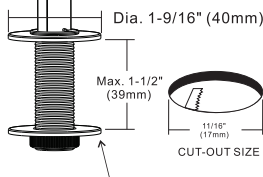

2pcs washers (included) for larger cut-out size.

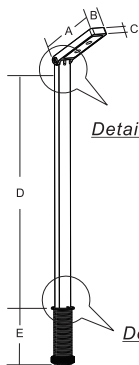

Detail 1

A	2-1/4" (56mm)
B	3/4" (18mm)
C	1/4" (6mm)
D	9" (229mm)
E	2" (50mm)

Detail 2

9" SUMMER 6 WATT HIGH POWER LED  
Item No. H5.12113

### SPECIFICATION:

- Input: 500 mA DC
- Power: 6 Watts
- Beam Angle: 100°

### CAUTION:

- Use Constant Current DC power supply only. Out-put current of the power supply should not be over 500mA.

- Check polarity of the power supply before linking with the light. Polarity of the light is



- These light should be linked to each other in series. Then you can turn on the power supply.

- Do not turn on the power supply before you have connected all the light together. This would result in burning out the LED bulbs.

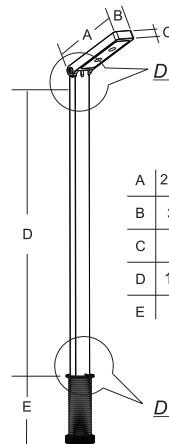

Detail 1

A	2-1/4" (56mm)
B	3/4" (18mm)
C	1/4" (6mm)
D	19" (483mm)
E	2" (50mm)

Detail 2

19" SUMMER 3 WATT HIGH POWER LED  
Item No. H5.12114

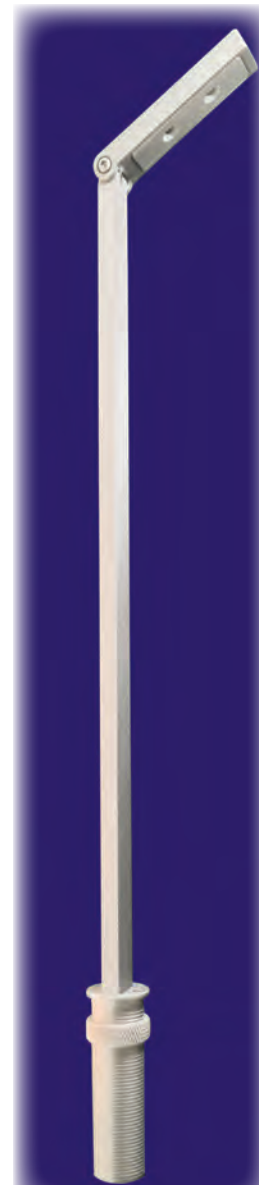

- Kitchens
- Doors
- Kitchen Accessories
- Hinges
- Drawer Slides
- Plywood Melamine
- Veneer Edgebanding
- Laminate
- Solid Surface
- Closets
- Furniture Hardware
- Pulls & Knobs
- Lighting
- Grommets
- Locks, Lock Systems
- Molding, Carvings
- Tools
- Adhesives Solvents Abrasives
- Chemicals Staples Screws

### REQUIRED COMPONENTS



DC - 41-512  
DC Junction Box



Item Number 41-506  
Connector

### OPTIONAL ACCESSORIES



### EXTENSION

ORDER #	SIZE
41-500	24"
41-502	36"
41-504	84"

Item Number	Input	Output	Amp/mA Watts
H5.12026	120v AC	500mA Constant Current 18 ~ 36V DC	500mA 20W
H5.12027	120v AC	500mA Constant Current 8 ~ 24V DC	500mA 12W

# Lighting

## High Power Display LED Lights

Splendor 100° Beam Angle

- Available 9" and 19"
- Cree LED
- Slim Design
- Ideal For Narrow Spaces
- Easy To Install
- Color Temperature Cool White
- 4000K ~ 5000K



Brilliant Modern Design, Ideal For Jewelry Displays, Showcases, Store Fixtures, Museums And Retail Applications. Low Energy Consumption, Rated At 40,000 Hours, Easily Adjustable For Custom Installation

**HEIGHT  
ADJUSTABLE**

### SPLENDOR 6 WATTS HIGH POWER LED

MODEL NUMBER	COLOR FINISH	HEIGHT	NUMBER OF LED'S	LUMENS	EFFICACY LUMEN / WATT	INPUT CONSTANT CURRENT	TOTAL WATTS	LIFE HOURS	BEAM ANGLE	CURRENT (A)	OPERATING TEMPERATURE	CRI
H5.12115-010	WHITE	9"	2	300 lm	50 lm	500mA	6W	40,000	100°	.5mA	25° C	85
H5.12115-014	BLACK	9"	2	300 lm	50 lm	500mA	6W	40,000	100°	.5mA	25° C	85
H5.12115-074	SATIN ALUMINUM	9"	2	300 lm	50 lm	500mA	6W	40,000	100°	.5mA	25° C	85
H5.12116-010	WHITE	19"	2	300 lm	50 lm	500mA	6W	40,000	100°	.5mA	25° C	85
H5.12116-014	BLACK	19"	2	300 lm	50 lm	500mA	6W	40,000	100°	.5mA	25° C	85

### LINKABLE POWER SUPPLY OPTIONS

			Fixture	5.12115	5.12116
H5.12026	POWER SUPPLY	500mA Constant Current 18 ~ 36V DC	Use with:	3 - 5 Lights	3 - 5 Lights
H5.12027	POWER SUPPLY	500mA Constant Current 8 ~ 24V DC	Use with:	2 Lights	2 Lights

**\* NOTE: Please Connect All Components Before Plugging into Electrical Outlet \***

**\* See Specifications and Accessories on Next Page \***

# Lighting

## High Power Display LED Lights

- Available 9" and 19"
- Cree LED
- Slim Design
- Ideal For Narrow Spaces
- Easy To Install
- Color Temperature Cool White
- 4000K ~ 5000K

### Detail 1

Using Allen Wrench, the head can be adjusted.

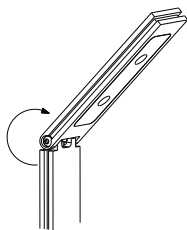

Allen Wrench included



### Detail 2

Using Allen Wrench, height of the rod can be adjusted.

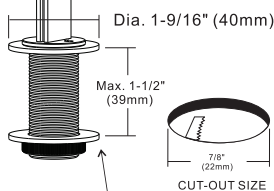

2pcs washers (included) for larger cut-out size.

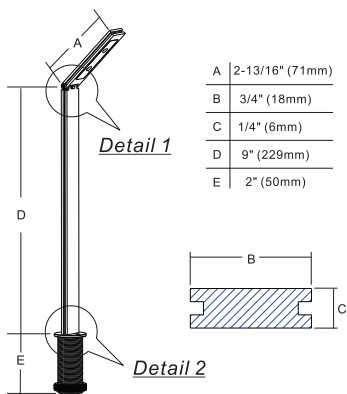

9" SPLENDOR 6 WATT HIGH POWER LED  
Item No. H5.12115

### SPECIFICATION:

- Input: 500 mA DC
- Power: 6 Watts
- Beam Angle: 100°

### CAUTION:

- Use Constant Current DC power supply only. Out-put current of the power supply should not be over 500mA.
- Check polarity of the power supply before linking with the light. Polarity of the light is 
- These light should be linked to each other in series. Then you can turn on the power supply.
- Do not turn on the power supply before you have connected all the light together. This would result in burning out the LED bulbs.

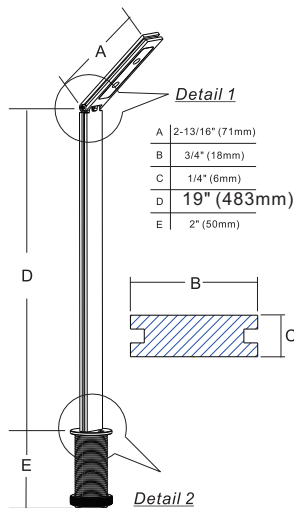

19" SPLENDOR 6 WATT HIGH POWER LED  
Item No. H5.12116

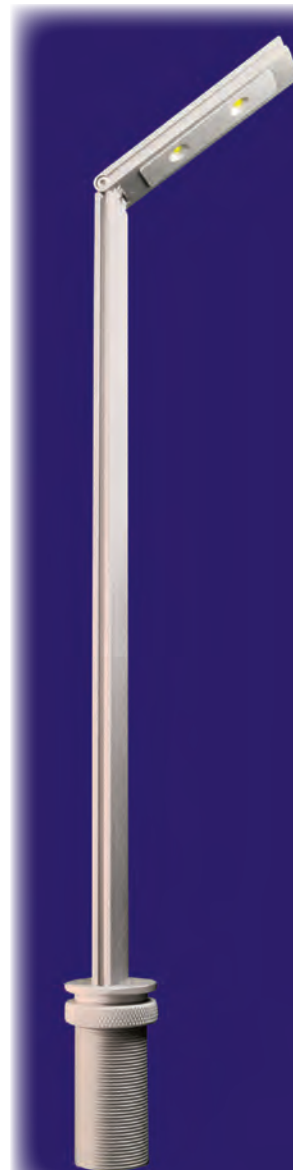

- Kitchens
- Doors
- Kitchen Accessories
- Hinges
- Drawer Slides
- Plywood Melamine
- Veneer Edgebanding
- Laminate
- Solid Surface
- Closets
- Furniture Hardware
- Pulls & Knobs
- Lighting
- Grommets
- Locks, Lock Systems

### REQUIRED COMPONENTS



DC - 41-512  
DC Junction Box



Item Number 41-506  
Connector

### OPTIONAL ACCESSORIES



### EXTENSION

ORDER #	SIZE
41-500	24"
41-502	36"
41-504	84"

- Molding, Carvings
- Tools
- Adhesives Solvents Abrasives
- Chemicals Staples Screws

Item Number	Input	Output	Amp/mA Watts
H5.12026	120v AC	500mA Constant Current 18 ~ 36V DC	500mA 20W
H5.12027	120v AC	500mA Constant Current 8 ~ 24V DC	500mA 12W

# Lighting

## High Power Display LED Lights

Splendor 60° Beam Angle

- Available 9" and 19"
- Cree LED
- Slim Design
- Ideal For Narrow Spaces
- Easy To Install
- Color Temperature Cool White
- 4000K ~ 5000K



Brilliant Modern Design, Ideal For Jewelry Displays, Showcases, Store Fixtures, Museums And Retail Applications. Low Energy Consumption, Rated At 40,000 Hours, Easily Adjustable For Custom Installation

**HEIGHT  
ADJUSTABLE**

### SPLENDOR 6 WATTS HIGH POWER LED

MODEL NUMBER	COLOR FINISH	HEIGHT	NUMBER OF LED'S	LUMENS	EFFICACY LUMEN / WATT	INPUT CONSTANT CURRENT	TOTAL WATTS	LIFE HOURS	BEAM ANGLE	CURRENT (A)	OPERATING TEMPERATURE	CRI
H5.12117-074	SATIN ALUMINUM	9"	2	300 lm	50 lm	500mA	6W	40,000	60°	.5mA	25° C	85
H5.12118-074	SATIN ALUMINUM	19"	2	300 lm	50 lm	500mA	6W	40,000	60°	.5mA	25° C	85

### LINKABLE POWER SUPPLY OPTIONS

Fixture				H5.12117	H5.12118
H5.12026	POWER SUPPLY	500mA Constant Current 18 ~ 36V DC		Use with: 3 - 5 Lights	3 - 5 Lights
H5.12027	POWER SUPPLY	500mA Constant Current 8 ~ 24V DC		Use with: 2 Lights	2 Lights

**\* NOTE: Please Connect All Components Before Plugging into Electrical Outlet \***

**\* See Specifications and Accessories on Next Page \***

## High Power Display LED Lights

- Available 9" and 19"
- Cree LED
- Slim Design
- Ideal For Narrow Spaces
- Easy To Install
- Color Temperature Cool White
- 6000K ~ 7000K

### Detail 1

Using Allen Wrench, the head can be adjusted.

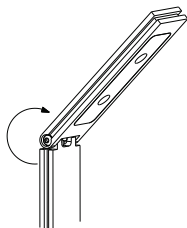

Allen Wrench included



### Detail 2

Using Allen Wrench, height of the rod can be adjusted.

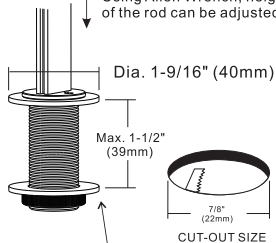

2pcs washers (included) for larger cut-out size.

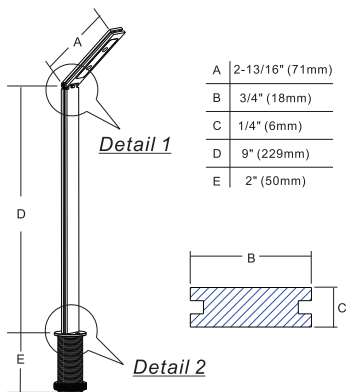

9" SPLENDOR 6 WATT HIGH POWER LED  
Item No. H5.12117

#### SPECIFICATION:

- Input: 500 mA DC
- Power: 6 Watts
- Beam Angle: 60°

#### CAUTION:

- Use Constant Current DC power supply only. Out-put current of the power supply should not be over 500mA.
- Check polarity of the power supply before linking with the light. Polarity of the light is 
- These light should be linked to each other in series. Then you can turn on the power supply.
- Do not turn on the power supply before you have connected all the light together. This would result in burning out the LED bulbs.

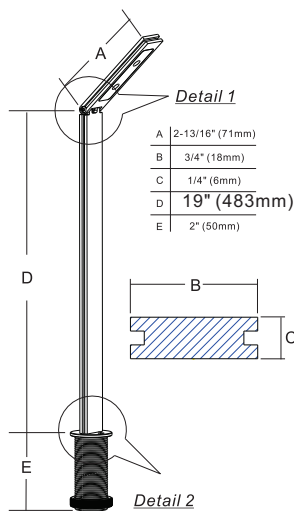

19" SPLENDOR 6 WATT HIGH POWER LED  
Item No. H5.12118

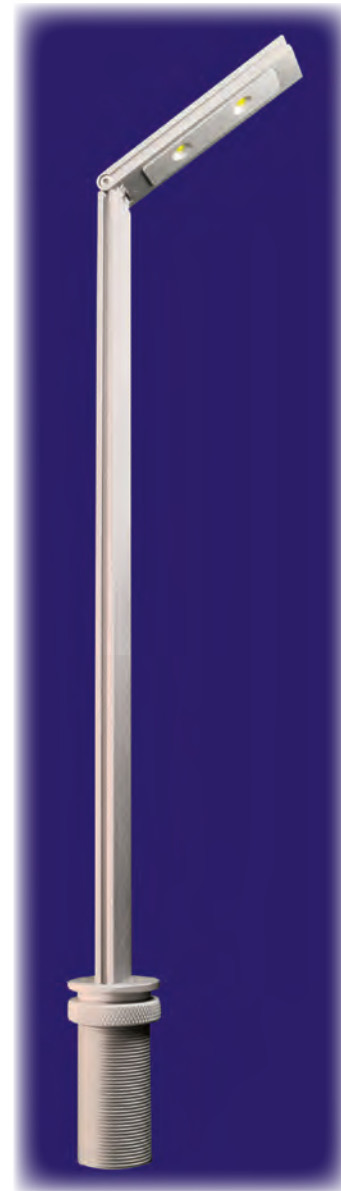

- Kitchens
- Doors
- Kitchen Accessories
- Hinges
- Drawer Slides
- Plywood Melamine
- Veneer Edgebanding
- Laminate
- Solid Surface
- Closets
- Furniture Hardware
- Pulls & Knobs
- Lighting
- Grommets
- Locks, Lock Systems
- Molding, Carvings
- Tools
- Adhesives Solvents Abrasives
- Chemicals Staples Screws

### REQUIRED COMPONENTS



DC - 41-512  
DC Junction Box



Item Number 41-506  
Connector

Item Number	Input	Output	Amp/mA Watts
H5.12026	120v AC	500mA Constant Current 18 ~ 36V DC	500mA 20W
H5.12027	120v AC	500mA Constant Current 8 ~ 24V DC	500mA 12W

### OPTIONAL ACCESSORIES



#### EXTENSION

ORDER #	SIZE
41-500	24"
41-502	36"
41-504	84"

Molding, Carvings

Tools

Adhesives Solvents Abrasives

Chemicals Staples Screws



## Display LED Light Panel

- 1 1/2" Minimum Can Depth
- Led Display Lights
- Epistar LED, Super Bright 3528 LED
- Slim Design
- Ideal For Narrow Spaces
- Easy To Install
- Color Temperature Cool White
- 5000K ~ 6000K



**DIMMABLE**



### LED LIGHT PANEL

FIXTURE	DESCRIPTION	SIZE	LUMENS	EFFICACY LUMEN / WATT	WATTAGE	VOLTAGE	BEAM SPREAD	UV RATING	EPISTAR
<b>H5.12009</b>	72 Pcs LED Panel	11-5/8" X 5-13/16"	500	100lm/w	5w	24V DC	120°	Free	82
<b>H5.12010</b>	36 Pcs LED Panel	5-13/16" X 5-13/16"	250	100lm/w	2.5w	24V DC	120°	Free	82
<b>H5.12012</b>	144 Pcs LED Panel	11-5/8" X 11-5/8"	1000	100lm/w	10w	24V DC	120°	Free	82

### POWER SUPPLY OPTIONS (Sold Separately)

Link up To

			Input	Output	Amp/mA Watts	Fixture:	<b>H5.12009</b>	<b>H5.12010</b>	<b>H5.12012</b>
<b>H5.00024</b>	POWER SUPPLY	240w POWER SUPPLY	120v~240v AC	24v DC	10A ~ 240W		<b>38</b>	<b>76</b>	<b>19</b>
<b>H5.12024</b>	POWER SUPPLY	75w POWER SUPPLY	120v~240v AC	24v DC	3A ~ 75W		<b>12</b>	<b>24</b>	<b>6</b>

**\* NOTE: Please Connect All Components Before Plugging into Electrical Outlet \***

### REQUIRED COMPONENTS



Item Number **H5.00024**  
See Technical information Page 81



PANEL TO PANEL CONNECTOR

ORDER #	SIZE
<b>H5.12701</b>	2-1/2"
<b>H5.12716</b>	6"
<b>H5.12736</b>	36"



Item Number **H5.12024**

### OPTIONAL ACCESSORIES



Item Number	<b>41-244</b>
Input	12v ~ 24v DC
Maximum Wattage	192 Watts
Amp	8A



POWER SUPPLY TO PANEL EXTENSION	
ORDER #	SIZE
<b>41-500</b>	24"
<b>41-502</b>	36"
<b>41-504</b>	84"

Kitchens

Doors

Kitchen Accessories

Hinges

Drawer Slides

Plywood Melamine

Veneer Edgebanding

Laminate

Solid Surface

Closets

Furniture Hardware

Pulls & Knobs

Lighting

Grommets

Locks, Lock Systems

Molding, Carvings

Tools

Adhesives Solvents Abrasives

Chemicals Staples Screws

## Display LED Light Panel



• LED Panels used for this application.

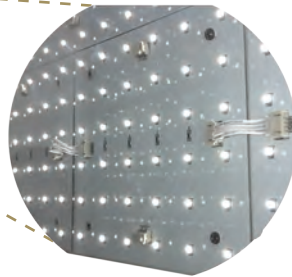

• More LEDs Per Inch



• Slim Design

### REQUIRED COMPONENTS



Item Number **H5.00024**  
See Technical information Page 81



PANEL TO PANEL  
CONNECTOR

ORDER #	SIZE
<b>H5.12701</b>	2-1/2"
<b>H5.12716</b>	6"
<b>H5.12736</b>	36"



Item Number **H5.12024**

### OPTIONAL ACCESSORIES



Item Number	<b>41-244</b>
Input	12v ~ 24v DC
Maximum Wattage	192 Watts
Amp	8A



POWER SUPPLY TO  
PANEL EXTENSION

ORDER #	SIZE
<b>41-500</b>	24"
<b>41-502</b>	36"
<b>41-504</b>	84"

Kitchens

Doors

Kitchen  
Accessories

Hinges

Drawer  
Slides

Plywood  
Melamine

Veneer  
Edgebanding

Laminate

Solid  
Surface

Closets

Furniture  
Hardware

Pulls  
&  
Knobs

Lighting

Grommets

Locks,  
Lock  
Systems

Molding,  
Carvings

Tools

Adhesives  
Solvents  
Abrasives

Chemicals  
Staples  
Screws

# Lighting

## LED Bright Track Light Fixture

- LED BRIGHT TRACK STRIP LIGHTS.
- SLIM DESIGN
- IDEAL FOR SMALLER SPACES
- EASY TO INSTALL, MOUNTING CLIPS PROVIDED
- 30,000 HOURS
- COLOR TEMPERATURE 6000K ~ 6500K



### BRIGHT TRACK HIGH POWER LED

FIXTURE	LENGTH	WATTS PER L.E.D.	LUMEN	EFFICACY LUMEN / WATT	LED NUMBER	INPUT VOLTAGE	TOTAL WATT
<b>H5.122127</b>	14"	3W	600	50	4	500mA Constant Current	12W
<b>H5.12227</b>	32"	3W	1350	50	9	500mA Constant Current	27W

### POWER SUPPLY (SOLD SEPARATELY)

		FIXTURE:	<b>H5.12217</b>	<b>H5.12227</b>
<b>H5.12026</b>	POWER SUPPLY	Use with:	2 Lights Min.	1
<b>H5.12027</b>	POWER SUPPLY	Use with:	1 Light	Do Not Use

**\* NOTE: Please Connect All Components Before Plugging into Electrical Outlet \***

### REQUIRED COMPONENTS



Item Number **H5.12026**

Item Number	Input	Output	Amp/mA Watts
<b>H5.12026</b>	120v AC	500mA Constant Current 18 ~ 36V DC	500mA 20W
<b>H5.12027</b>	120v AC	500mA Constant Current 8 ~ 24V DC	500mA 12W

### OPTIONAL ACCESSORIES



DC - **41-512**  
DC Junction Box



### EXTENSION

ORDER #	SIZE
<b>41-500</b>	24"
<b>41-502</b>	36"
<b>41-504</b>	84"



Item Number **41-506**  
Connector

Kitchens

Doors

Kitchen Accessories

Hinges

Drawer Slides

Plywood Melamine

Veneer Edgebanding

Laminate

Solid Surface

Closets

Furniture Hardware

Pulls & Knobs

Lighting

Grommets

Locks, Lock Systems

Molding, Carvings

Tools

Adhesives Solvents Abrasives

Chemicals Staples Screws

# Lighting

## LED Bright Track Light Fixture

- LED BRIGHT TRACK STRIP LIGHTS.
  - SLIM DESIGN
  - IDEAL FOR SMALLER SPACES
- EASY TO INSTALL, MOUNTING CLIPS PROVIDED
  - 30,000 HOURS
- COLOR TEMPERATURE 6000K ~ 6500K



### BRIGHT TRACK HIGH POWER LED WITH COVER

FIXTURE	LENGTH	WATTS PER L.E.D.	LUMEN	EFFICACY LUMEN / WATT	LED NUMBER	INPUT VOLTAGE	TOTAL WATT
<b>H5.12212-4200</b>	14"	3W	600	50	4	500mA Constant Current	12W
<b>H5.12236</b>	42"	3W	1800	50	12	700mA Constant Current	36W

### POWER SUPPLY (SOLD SEPARATELY)

		FIXTURE:	<b>H5.12212-4200</b>	<b>H5.12236</b>
<b>H5.12025</b>	POWER SUPPLY	Use with:	<b>Do not Use.</b>	<b>1</b>
<b>H5.12026</b>	POWER SUPPLY	Use with:	<b>2 Lights Min.</b>	<b>Do not Use.</b>
<b>H5.12027</b>	POWER SUPPLY	Use with:	<b>1</b>	<b>Do not Use.</b>

**\* NOTE: Please Connect All Components Before Plugging into Electrical Outlet \***

### REQUIRED COMPONENTS



Item Number **H5.12025**  
See Technical information Page 82



Item Number **H5.12026**

Item Number	Input	Output	Amp/mA Watts
<b>H5.12025</b>	120v AC	700mA Constant Current 9 ~ 48V DC	700mA 36W
<b>H5.12026</b>	120v AC	500mA Constant Current 18 ~ 36V DC	500mA 20W
<b>H5.12027</b>	120v AC	500mA Constant Current 8 ~ 24V DC	500mA 12W

### OPTIONAL ACCESSORIES



**DC - 41-512**  
DC Junction Box

### EXTENSION

ORDER #	SIZE
<b>41-500</b>	24"
<b>41-502</b>	36"
<b>41-504</b>	84"



Item Number **41-506**  
Connector

Kitchens

Doors

Kitchen Accessories

Hinges

Drawer Slides

Plywood Melamine

Veneer Edgbanding

Laminate

Solid Surface

Closets

Furniture Hardware

Pulls & Knobs

Lighting

Grommets

Locks, Lock Systems

Molding, Carvings

Tools

Adhesives Solvents Abrasives

Chemicals Staples Screws

# Lighting

## LED Strip Light Fixture

- DIMMABLE
- LED CLEAR STRIP LIGHTS.
- LINK UP TO 15 LIGHTS WITH ONE POWER SUPPLY
- SLIM DESIGN
- WARM & COOL WHITE COLOR TEMPERATURE
- IDEAL FOR SMALLER SPACES
- EASY TO CREATE 90° ANGLES
- 3M ADHESIVE TAPE



### LINKABLE LED STRIP LIGHT

	FIXTURE	DESCRIPTION	LENGTH	OVERALL THICKNESS	LUMENS	BULB LIFE	CRI	COLOR TEMP	WATTAGE	VOLTAGE	BEAM SPREAD	UV RATING	HEAT SINK
Closets	41-460C	COOL WHITE	12"	8mm	250	40,000 Hrs.	75	5000-6000K	2.5w	12v DC	120°	Free	Plastic Housing
	41-460W	WARM WHITE	12"	8mm	200	40,000 Hrs.	75	2700-3500K	2.5w	12v DC	120°	Free	Plastic Housing
Furniture Hardware	41-462C	COOL WHITE	16"	8mm	300	40,000 Hrs.	75	5000-6000K	3w	12v DC	120°	Free	Plastic Housing
	41-462W	WARM WHITE	16"	8mm	240	40,000 Hrs.	75	2700-3500K	3w	12v DC	120°	Free	Plastic Housing

### LINKABLE POWER SUPPLY OPTIONS

	FIXTURE			41-460	41-462	Watt	
Lighting	41-456	POWER SUPPLY	12V 1 amp POWER SUPPLY	LINK UP TO	5 Strips	4 Strips	12W
	41-454	POWER SUPPLY	12V 3 amp POWER SUPPLY	LINK UP TO	15 Strips	12 Strips	36W
	H5.00012	POWER SUPPLY	12V 12.5 amp POWER SUPPLY	LINK UP TO	45 Strips	30 Strips	150W

**DIMMABLE**

### REQUIRED COMPONENTS



Item Number	Input	Output	Amp / Watts
H5.00012	120v AC	12v DC	12.5 Amp / 150W
41-456	120v AC	12v DC	1 Amp / 12W
41-454	120v AC	12v DC	3 Amp / 36W

### OPTIONAL ACCESSORIES

FOR CONNECTING MULTIPLE LIGHTS



Item Number	41-244
Input	12v ~ 24v DC
Maximum Wattage	192 Watts
Amp	8A



### EXTENSION

ORDER #	SIZE
H5.12036	36"

## LED Strip Light Bar

- DIMMABLE
- ULTRA SLIM DESIGN
- EXTREMELY LONG LIFE (OVER 50,000 HOURS)
- VIRTUALLY NO HEAT EMISSIONS
- LOW ENERGY CONSUMPTION
- ULTRA BRIGHT 6400K RIGID SMD BOARD



**DIMMABLE**



C-Shape Mounting Clip  
Included with Fixture  
41-482



C-Shape Metal Mounting Clip  
with Magnet (Optional)  
41-485



- Kitchens
- Doors
- Kitchen Accessories
- Hinges
- Drawer Slides
- Plywood Melamine
- Veneer Edgebanding
- Laminate
- Solid Surface
- Closets

### LED ALUMINUM LIGHT BAR

FIXTURE	LENGTH	OVERALL Thickness	LUMENS	BULB LIFE	COLOR TEMP	WATTAGE	VOLTAGE	BEAM SPREAD	UV RATING	HEAT SINK
41-470	12"	1/2"	250	50,000 Hours	6400K	4.5w	24v DC	120°	Free	Aluminium
41-472	24"	1/2"	500	50,000 Hours	6400K	9w	24v DC	120°	Free	Aluminium
41-474	36"	1/2"	750	50,000 Hours	6400K	15w	24v DC	120°	Free	Aluminium
41-476	48"	1/2"	1000	50,000 Hours	6400K	20w	24v DC	120°	Free	Aluminium
41-478	60"	1/2"	1250	50,000 Hours	6400K	25w	24v DC	120°	Free	Aluminium

### LINKABLE POWER SUPPLY OPTIONS

FIXTURE	41-470	41-472	41-474	41-476	41-478
H5.12024	10	6	4	3	2
H5.00024	25	20	14	10	8

- Furniture Hardware
- Pulls & Knobs
- Lighting

### REQUIRED COMPONENTS

Item Number **H5.00024**  
See Technical Information Page 81



Item Number **H5.12024**

Item Number	Input	Output	Amp/mA Watts
<b>H5.00024</b>	120v~240v AC	24v DC	10A ~ 250W
<b>H5.12024</b>	120v~240v AC	24v DC	3A ~ 75W

### OPTIONAL ACCESSORIES



Item Number	<b>41-244</b>
Input	12v ~ 24v DC
Maximum Wattage	192 Watts
Amp	8A



EXTENSION	
ORDER #	SIZE
<b>H5.12636</b>	36"

- Grommets
- Locks, Lock Systems
- Molding, Carvings
- Tools
- Adhesives Solvents Abrasives
- Chemicals Staples Screws

# Lighting

## Anodize Aluminum Light Bar Components

Kitchens

Doors

Kitchen Accessories

Hinges

Drawer Slides

Plywood Melamine

Veneer Edgebanding

Laminate

Solid Surface

Closets

Furniture Hardware

Pulls & Knobs

Lighting



Light Bar Assembly



Aluminum Extrusion  
41-480

White Plastic Diffuser  
41-481

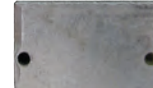

End Cap  
41-483



End Cap w/ Wire Hole  
41-484



C-Shape Mounting Clip  
41-482



C-Shape Metal Mounting Clip with Magnet  
41-485

**DIMMABLE**



LED Strip Light  
41-440D

41-480	ANODIZED ALUMINUM EXTRUSION 3 METERS / 10 Lft.
41-481	WHITE PLASTIC DIFFUSER LENS 3 METERS / 10 Lft.
41-482	C-SHAPE METAL MOUNTING CLIP
41-483	ALUMINIUM EXTRUSION END CAP
41-484	ALUMINIUM EXTRUSION END CAP W/WIRE HOLE
41-485	C-SHAPE METAL MOUNTING CLIP WITH MAGNET

### FLEXIBLE LED STRIP LIGHT / 3M ADHESIVE TAPE

FIXTURE	DESCRIPTION	BULB LIFE	COLOR TEMP	CRI	VOLTAGE	BEAM SPREAD	WATTS PER METER	LUMENS	LUMENS PER METER
41-440D	FLEX LIGHT	50,000 Hours	6000k ~ 6500k	70	24v DC	120°	14W	5000	1000

#### REQUIRED COMPONENTS



Item Number H5.00024  
See Technical information Page 81



Item Number H5.12024

Item Number	Input	Output	Amp/mA Watts
H5.00024	120v~240v AC	24v DC	10A ~ 250W
H5.12024	120v~240v AC	24v DC	3A ~ 75W

#### OPTIONAL ACCESSORIES FOR CONNECTING MULTIPLE LIGHTS



Item Number	41-244
Input	12v ~ 24v DC
Maximum Wattage	192 Watts
Amp	8A



#### EXTENSION

ORDER #	SIZE
41-500	24"
41-502	36"
41-504	84"

# Lighting

## LED Flexible Strip Light

- DIMMABLE SMD3528 LEDs
  - ULTRA SLIM DESIGN
- EXTREMELY LONG LIFE (OVER 50,000 HOURS)
- VIRTUALLY NO HEAT EMISSIONS
- LOW ENERGY CONSUMPTION
  - 4.8 WATTS PER METER
  - INDOOR USE ONLY
  - 60 LEDS PER METER

**DIMMABLE**

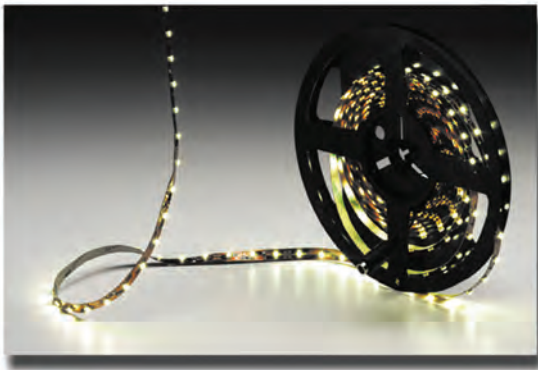

EASY TO CUT & INSTALL.  
CREATE CUSTOM CUTS WITH ONLY THE USE OF A SCISSORS

H5.12501

6" LED Quick Connector  
Strip to Strip Solderless Connector

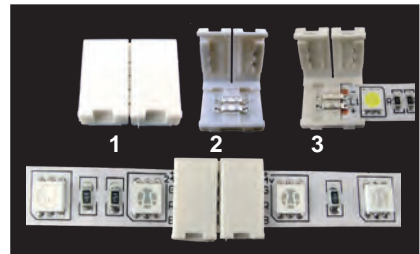

Item Number H5.12502  
LED Quick Connector  
Single Color LED Connector

### FLEXIBLE LED STRIP LIGHT / 3M ADHESIVE TAPE

FIXTURE	DESCRIPTION	BULB LIFE	COLOR TEMP	CRI	VOLTAGE	BEAM SPREAD	UV RATING	HEAT SINK
41-451	COOL WHITE	50,000 Hours	4000-5000K	70	12V DC	120°	Free	N/A
41-450	DAY LIGHT	50,000 Hours	6000-7000K	70	12V DC	120°	Free	N/A
41-452	WARM WHITE	50,000 Hours	2700-3500K	70	12V DC	120°	Free	N/A

### LINKABLE POWER SUPPLY OPTIONS

				41-451	41-450	41-452
41-456	POWER SUPPLY	12V 1 amp 12W POWER SUPPLY - (SOLD SEPARATELY)	Link Up to	Up to 8 Lft	Up to 8 Lft	Up to 8 Lft
41-454	POWER SUPPLY	12V 3 amp 36W POWER SUPPLY - (SOLD SEPARATELY)	Link Up to	Up to 24 Lft	Up to 24 Lft	Up to 24 Lft
H5.00012	POWER SUPPLY	12V 12.5 amp 150W POWER SUPPLY - (SOLD SEPARATELY)	Link Up to	Up to 65 Lft	Up to 65 Lft	Up to 65 Lft

### REQUIRED COMPONENTS



Item Number H5.00012  
See Technical information Page 80



Item No. 41-454



Item Number 41-456

Item Number	Input	Output	Amp / Watts
H5.00012	120v AC	12v DC	12.5 Amp / 150W
41-456	120v AC	12v DC	1 Amp / 12W
41-454	120v AC	12v DC	3 Amp / 36W

### OPTIONAL ACCESSORIES FOR CONNECTING MULTIPLE LIGHTS



Item Number	41-244
Input	12v ~ 24v DC
Maximum Wattage	192 Watts
Amp	8A



### EXTENSION

ORDER #	SIZE
41-500	24"
41-502	36"
41-504	84"

Kitchens

Doors

Kitchen Accessories

Hinges

Drawer Slides

Plywood Melamine

Veneer Edgbanding

Laminate

Solid Surface

Closets

Furniture Hardware

Pulls & Knobs

Lighting

Grommets

Locks, Lock Systems

Molding, Carvings

Tools

Adhesives Solvents Abrasives

Chemicals Staples Screws



# Lighting

## Glue Drop LED Flexible Strip Lights

- DIMMABLE • 5.4 WATTS PER METER
- IP44 RATING INDOOR / OUTDOOR USE
- MOISTURE AND SPLASH RESISTANT
- ULTRA SLIM DESIGN • SMD5050 LEDS
- EXTREMELY LONG LIFE (OVER 50,000 HOURS)
- VIRTUALLY NO HEAT EMISSIONS • LOW ENERGY CONSUMPTION
- 30 LEDS PER METER



**DIMMABLE**



### IP44 FLEXIBLE LED STRIP LIGHT / 3M ADHESIVE TAPE

FIXTURE	DESCRIPTION	BULB LIFE	COLOR TEMP	CRI	VOLTAGE	BEAM SPREAD	WATTS PER METER	UV RATING	HEAT SINK
<b>41-446D</b>	FLEX LIGHT	50,000 Hours	6000k ~ 6500k	70	24v DC	120°	5.4W	Free	N/A
<b>41-446W</b>	FLEX LIGHT	50,000 Hours	3000k ~ 3500k	70	24v DC	120°	5.4W	Free	N/A

### LINKABLE POWER SUPPLY OPTIONS

			<b>41-446D</b>	<b>41-446W</b>
<b>H5.00024</b>	POWER SUPPLY	24v 10 amp 240W POWER SUPPLY - (SOLD SEPARATELY)	Link up to	Up to 98 Lft
<b>H5.12024</b>	POWER SUPPLY	24v 3 amp 75W POWER SUPPLY - (SOLD SEPARATELY)	Link up to	Up to 35 Lft

### REQUIRED COMPONENTS



Item Number	Input	Output	Amp/ma Watts
<b>H5.00024</b>	120v~240v AC	24v DC	10A ~ 250W
<b>H5.12024</b>	120v~240v AC	24v DC	3A ~ 75W

### OPTIONAL ACCESSORIES FOR CONNECTING MULTIPLE LIGHTS



Item Number	<b>41-244</b>
Input	12v ~ 24v DC
Maximum Wattage	192 Watts
Amp	8A



EXTENSION	
ORDER #	SIZE
<b>41-500</b>	24"
<b>41-502</b>	36"
<b>41-504</b>	84"

Kitchens

Doors

Kitchen Accessories

Hinges

Drawer Slides

Plywood Melamine

Veneer Edgebanding

Laminate

Solid Surface

Closets

Furniture Hardware

Pulls & Knobs

Lighting

Grommets

Locks, Lock Systems

Molding, Carvings

Tools

Adhesives Solvents Abrasives

Chemicals Staples Screws

# Lighting

## LED Flexible Light Strips

- DIMMABLE • 14 WATTS PER METER
- ULTRA BRIGHT SMD5050 FLEXIBLE STRIP LIGHT
  - SLIM DESIGN • INDOOR USE ONLY
  - EXTREMELY LONG LIFE (OVER 50,000 HOURS)
- VIRTUALLY NO HEAT EMISSIONS • LOW ENERGY CONSUMPTION
  - 1 ROLL 16.25 Lft



**DIMMABLE**

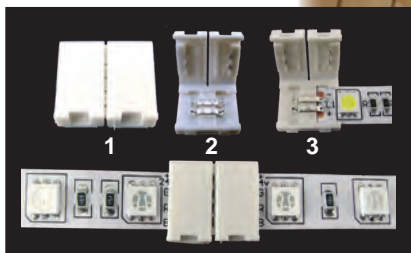

Item Number **H5.12402**  
LED Quick Connector  
Single Color LED Connector



**H5.12401**  
6" LED Quick Connector  
Strip to Strip Solderless Connector



### FLEXIBLE LED STRIP LIGHT / 3M ADHESIVE TAPE

FIXTURE	DESCRIPTION	BULB LIFE	COLOR TEMP	CRI	VOLTAGE	BEAM SPREAD	WATTS PER METER	UV RATING	HEAT SINK
<b>41-440D</b>	FLEX LIGHT	50,000 Hours	6000k ~ 6500k	70	24v DC	120°	14W	Free	N/A

### LINKABLE POWER SUPPLY OPTIONS

								<b>41-440D</b>	
<b>H5.00024</b>	POWER SUPPLY	24V 10 amp 240W POWER SUPPLY - (SOLD SEPARATELY)						Link up to	Up to 49 Lft
<b>H5.12024</b>	POWER SUPPLY	24V 3 amp 75W POWER SUPPLY - (SOLD SEPARATELY)						Link up to	Up to 16.25 Lft

### REQUIRED COMPONENTS



Item Number **H5.00024**  
See Technical information Page 81



Item Number **H5.12024**

Item Number	Input	Output	Amp/ mA Watts
<b>H5.00024</b>	120v~240v AC	24v DC	10A ~ 250W
<b>H5.12024</b>	120v~240v AC	24v DC	3A ~ 75W

### OPTIONAL ACCESSORIES FOR CONNECTING MULTIPLE LIGHTS



Item Number	<b>41-244</b>
Input	12v ~ 24v DC
Maximum Wattage	192 Watts
Amp	8A



### EXTENSION

ORDER #	SIZE
<b>41-500</b>	24"
<b>41-502</b>	36"
<b>41-504</b>	84"

- Kitchens
- Doors
- Kitchen Accessories
- Hinges
- Drawer Slides
- Plywood Melamine
- Veneer Edgbanding
- Laminate
- Solid Surface
- Closets
- Furniture Hardware
- Pulls & Knobs
- Lighting
- Grommets
- Locks, Lock Systems
- Molding, Carvings
- Tools
- Adhesives Solvents Abrasives
- Chemicals Staples Screws

# RGB LED Flexible Light



# Lighting

## RGB LED Flexible Strip Light Kit

- IP67 SMD RGB COLOR CHANGING FLEXIBLE LIGHT
  - 7W PER METER
  - ULTRA SLIM DESIGN
- EXTREMELY LONG LIFE (OVER 50,000 HOURS)
  - VIRTUALLY NO HEAT EMISSIONS
  - LOW ENERGY CONSUMPTION

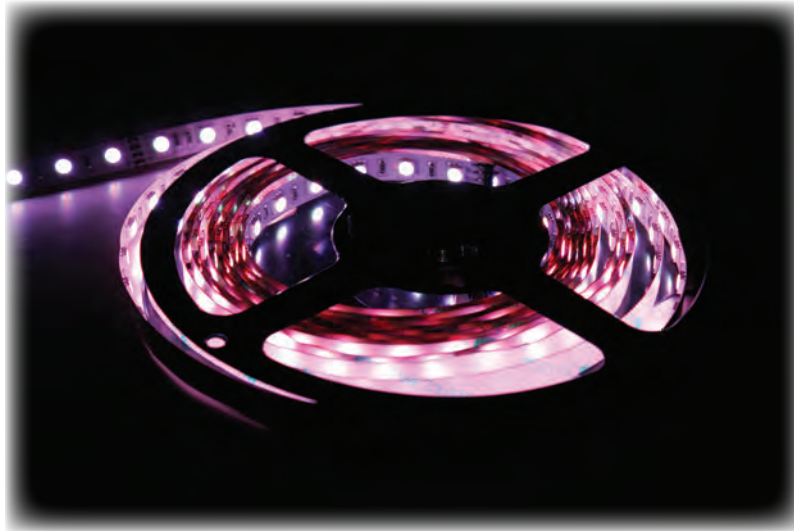

### Includes:

- 1 - Roll 16.25 Lft (5 m) SMD RGB Color Changing Flexible Strip Light
- 1 - Power Supply
- 1 - 24 Key RGB Controller
- 1 - IR Control Receiver



30 LEDs Per Meter, 150 LEDs Total

DIY Lights For Use With:  
 Hallways  
 Stairs  
 Trails  
 Windows  
 Porches / Decks  
 Bridge Edge Lighting  
 Emergency Exit Rows  
 Ideal for Back Lighting

### RGB FLEXIBLE LED STRIP LIGHT KIT / 3M ADHESIVE TAPE

FIXTURE	DESCRIPTION	BULB LIFE	COLOR TEMP	CRI	VOLTAGE	BEAM SPREAD	UV RATING
<b>41-442KIT</b>	RGB FLEX LIGHT	50,000 Hrs	RGB	75	12v DC	120°	Free
12V 24 KEY RGB CONTROLLER WITH REMOTE - (INCLUDED)							

- Kitchens
- Doors
- Kitchen Accessories
- Hinges
- Drawer Slides
- Plywood Melamine
- Veneer Edgebanding
- Laminate
- Solid Surface
- Closets
- Furniture Hardware
- Pulls & Knobs
- Lighting
- Grommets
- Locks, Lock Systems
- Molding, Carvings
- Tools
- Adhesives Solvents Abrasives
- Chemicals Staples Screws

# Lighting

## RGB LED Flexible Strip Light

- 24V SMD5050 COLOR CHANGING LED STRIP LIGHT
  - 14.4W PER METER
  - ULTRA SLIM DESIGN
- EXTREMELY LONG LIFE (OVER 50,000 HOURS)
  - VIRTUALLY NO HEAT EMISSIONS
  - LOW ENERGY CONSUMPTION
  - INDOOR USE ONLY

Kitchens

Doors

Kitchen Accessories

Hinges

Drawer Slides

Plywood Melamine

Veneer Edgebanding

Laminate

Solid Surface

Closets

Furniture Hardware

Pulls & Knobs

Lighting

Grommets

Locks, Lock Systems

Molding, Carvings

Tools

Adhesives Solvents Abrasives

Chemicals Staples Screws

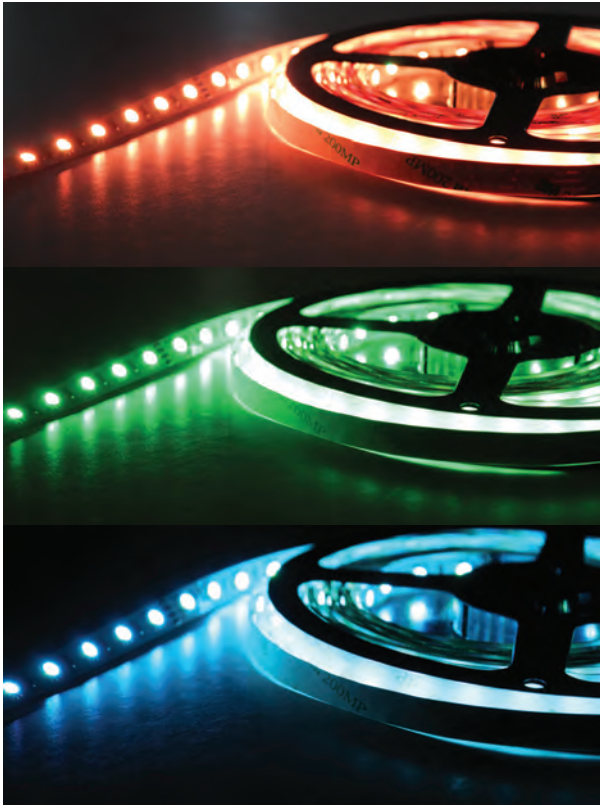

EASY TO CUT & INSTALL.

CREATE CUSTOM CUTS WITH ONLY THE USE OF A SCISSORS  
SOME SOLDERING MAY BE REQUIRED  
SEE ADDITIONAL LINKING COMPONENTS ON NEXT PAGE



### RGB FLEXIBLE LED STRIP LIGHT / 3M ADHESIVE TAPE

FIXTURE	DESCRIPTION	BULB LIFE	COLOR TEMP	CRI	VOLTAGE	BEAM SPREAD	UV RATING	HEAT SINK
<b>41-444RGB</b>	RGB FLEX LIGHT	50,000 Hours	RGB	75	24v DC	120°	Free	N/A
<b>41-445RGB</b>	24V DC 8 KEY RGB CONTROLLER WITH REMOTE - (SOLD SEPARATELY)							

### LINKABLE POWER SUPPLY OPTIONS

					<b>41-444RGB</b>
<b>H5.00024</b>	POWER SUPPLY	24V 10 amp 240W POWER SUPPLY - (SOLD SEPARATELY)		LINK UP TO	49 Lft
<b>H5.12024</b>	POWER SUPPLY	24V 3 amp 75W POWER SUPPLY - (SOLD SEPARATELY)		LINK UP TO	16.25 Lft

\* See Specifications and Accessories on Next Page \*

# Lighting

## LED Bright Track Light Fixture

- ULTRA SLIM DESIGN
- EXTREMELY LONG LIFE (OVER 50,000 HOURS)
- VIRTUALLY NO HEAT EMISSIONS
- LOW ENERGY CONSUMPTION



### RGB CONTROLLER

Item Number	Input
<b>41-445RGB</b>	12v~24v DC

### RGB Controller Features:

- 8 Key Remote Control
- 25 Preset Settings
- 7 Static Colors



### Item Number **H5.12401**

6" LED Quick Connector  
Strip to Strip Solderless Connector

<b>H5.12401</b>	6" LED RGB Corner Connector
<b>H5.12402</b>	LED RGB Quick Connector

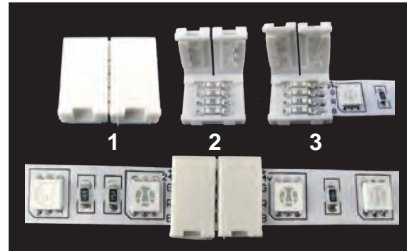

### Item Number **H5.12402** LED RGB Quick Connector Strip to Strip Solderless Connector

### REQUIRED COMPONENTS



Item Number **H5.00024**  
See Technical information Page 81



Item Number **H5.12024**

Item Number	Input	Output	Amp/mA Watts
<b>H5.00024</b>	120v~240v AC	24v DC	10A ~ 250W
<b>H5.12024</b>	120v~240v AC	24v DC	3A ~ 75W

### OPTIONAL ACCESSORIES



### EXTENSION

ORDER #	SIZE
<b>41-500</b>	24"
<b>41-502</b>	36"
<b>41-504</b>	84"

Kitchens

Doors

Kitchen  
Accessories

Hinges

Drawer  
Slides

Plywood  
Melamine

Veneer  
Edgebanding

Laminate

Solid  
Surface

Closets

Furniture  
Hardware

Pulls  
&  
Knobs

Lighting

Grommets

Locks,  
Lock  
Systems

Molding,  
Carvings

Tools

Adhesives  
Solvents  
Abrasives

Chemicals  
Staples  
Screws

# Lighting

## 15 Watt High Power LED Swivel Light

Kitchens

Doors

Kitchen Accessories

Hinges

Drawer Slides

Plywood Melamine

Veneer Edgbanding

- UV FREE
- 5 X 3 WATT CREE LED
- EXTREMELY LONG LIFE
- EASY TO INSTALL
- SAFETY LOW VOLTAGE INPUT
- HI-LUMEN OUTPUT - SUPER BRIGHT



Trim Ring Sold Separately  
Item Number **H5.94115-078**

The Future Of Displays, Bookcases, Entertainment Centers, Work Stations, Computer Desks, Garages, Kitchens And Bathrooms.

Laminate

### HIGH POWER LED ANGLE LIGHT

FIXTURE	COLOR FINISH	BEAM ANGLE	COLOR TEMP	WATTS PER LED	EFFICACY LUMEN / WATT	LED NUMBER	LUMEN	INPUT
<b>H5.94015-60</b>	SATIN CHROME	60°	7000K	3W	57	5	850	500mA Constant Current
<b>H5.94015-25</b>	SATIN CHROME	25°	7000K	3W	57	5	850	500mA Constant Current
<b>H5.94015-45</b>	SATIN CHROME	45°	2700K	3W	45	5	680	500mA Constant Current
<b>H5.94115-078</b>	SATIN CHROME TRIM RING FOR LED ENGINE LIGHT - (REQUIRED -SOLD SEPARATELY)							

Solid Surface

Closets

Furniture Hardware

Pulls & Knobs

Lighting

Grommets

Locks, Lock Systems

Molding, Carvings

Tools

Adhesives Solvents Abrasives

Chemicals Staples Screws



**H5.94015** LED ENGINE LIGHT  
(Without Trim Ring)

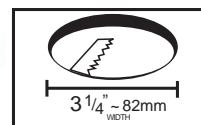
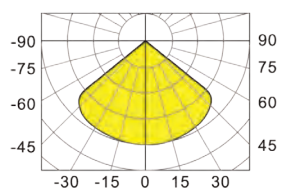
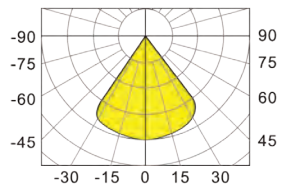
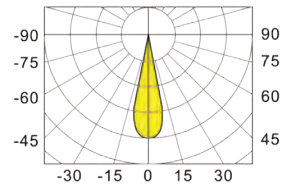
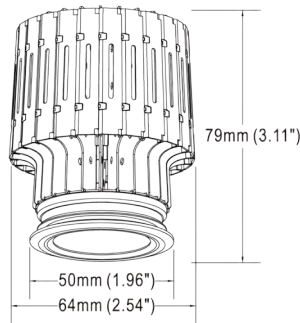

SATIN CHROME TRIM RING FOR LED ENGINE LIGHT  
ITEM NUMBER **H5.94115-078**  
(REQUIRED -SOLD SEPARATELY)

**CUT-OUT SIZE**

# Lighting

## 15 Watt High Power LED Swivel Light

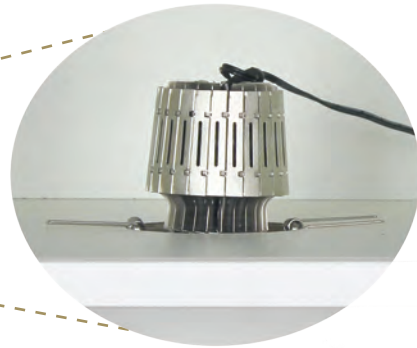

Easy Install



Pivot Head

Ideal For Displays, Showcases, Store Fixtures, Museums And Retail Applications. Low Energy Consumption, Rated At 40,000 Hours, Easily Adjustable, Easy Installation.

- Kitchens
- Doors
- Kitchen Accessories
- Hinges
- Drawer Slides
- Plywood Melamine
- Veneer Edgebanding
- Laminate
- Solid Surface
- Closets
- Furniture Hardware
- Pulls & Knobs
- Lighting

### LINKABLE POWER SUPPLY OPTIONS

				<b>H5.94015</b>
<b>H5.12026</b>	POWER SUPPLY	500mA Constant Current 18 ~ 36V DC - (SOLD SEPARATELY)	Use with:	2
<b>H5.12027</b>	POWER SUPPLY	500mA Constant Current 8 ~ 24V DC - (SOLD SEPARATELY)	Use with:	1

### REQUIRED COMPONENTS



Item Number	Input	Output	Amp/mA Watts
<b>H5.12026</b>	120v AC	500mA Constant Current 18 ~ 36V DC	500mA 20W
<b>H5.12027</b>	120v AC	500mA Constant Current 8 ~ 24V DC	500mA 12W

### OPTIONAL ACCESSORIES



DC - 41-512  
DC Junction Box



#### EXTENSION

ORDER #	SIZE
<b>41-500</b>	24"
<b>41-502</b>	36"
<b>41-504</b>	84"



Item Number **41-506**  
Connector

- Grommets
- Locks, Lock Systems
- Molding, Carvings
- Tools
- Adhesives Solvents Abrasives
- Chemicals Staples Screws



## 15 Watt High Power LED Track Light

- UV FREE
- 5 X 3 WATT CREE LED
- EXTREMELY LONG LIFE
- EASY TO INSTALL
- SAFETY LOW VOLTAGE INPUT
- HI-LUMEN OUTPUT - SUPER BRIGHT



The Future Of Displays, Garages, Kitchens And Bathrooms. Featuring quality you can see. For Interior Use

### HIGH POWER LED TRACK LIGHT

FIXTURE	COLOR FINISH	BEAM ANGLE	COLOR TEMP	WATTS PER LED	EFFICACY LUMEN / WATT	LED NUMBER	LUMEN	INPUT
41-430	WHITE	45°	7000K	3W	57	5	850	500mA Constant Current
41-431	WHITE	HIGH POWER LED SPOT LIGHT						



4' LED Track Lighting Track  
Item Number 41-432 - White



LED Track Lighting Straight Connector  
Joins Two Track Sections  
Item Number 41-433

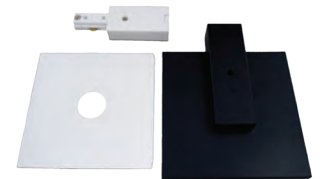

LED Track Lighting End Power Feed with Cover  
Item Number 41-434



LED Track Lighting 90° Corner Connector  
Item Number 41-435



LED Track Lighting Floating Power Feed  
Item Number 41-436



LED Track Lighting End Connector Feed  
With 15 Ft. Cord and Switch  
Item Number 41-437

Kitchens

Doors

Kitchen Accessories

Hinges

Drawer Slides

Plywood Melamine

Veneer Edgebanding

Laminate

Solid Surface

Closets

Furniture Hardware

Pulls & Knobs

Lighting

Grommets

Locks, Lock Systems

Molding, Carvings

Tools

Adhesives Solvents Abrasives

Chemicals Staples Screws

# Lighting

## High Power LED Lights

- 1 X 1W HIGH POWER LED
- EXTREMELY LONG LIFE (OVER 50,000 HOURS)
- VIRTUALLY NO HEAT EMISSIONS
- LOW ENERGY CONSUMPTION

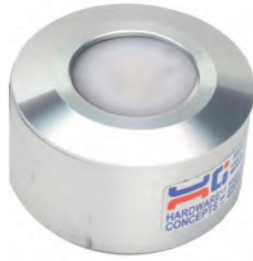

**U. L. LISTED**

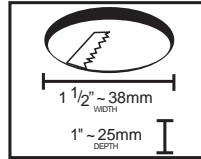

CUT-OUT SIZE



### HIGH POWER LED LIGHT

FIXTURE	COLOR / FINISH	DIA OVERALL	OVERALL THICKNESS	LUMENS	BULB LIFE	CRI	COLOR TEMP	WATTAGE	BEAM SPREAD	UV RATING	HEAT SINK
<b>H5.12060-SS</b>	STAINLESS STEEL	44mm	26mm	100	50,000 Hours	80	5000K	1 X 1W	120°	Free	Alu.
<b>41-514</b>	POWER SUPPLY & JUNCTION BOX ( Sold Separately)										

## CABINET AND DISPLAY LIGHTING

- UV Free
- Heat Free
- Energy Saving (Only 1w)
- Extremely Long Life
- Easy Install - Just Plug In
- Hi-Lumen Output - Super Bright
- The Future Of Kitchens, Garages, Book Cases, Bathrooms, Work Stations, Computer Desks, Entertainment Centers
- Surface And Recessed Mounting



Use for 3 Light Kit Option

Item Number **41-514**  
 Input: 350mA Constant Current  
 Output: 30v 350mA  
 Connect up to 6 Lights

### Extension Cord (Sold Separately)



ORDER #	SIZE
<b>41-500</b>	24"
<b>41-502</b>	36"
<b>41-504</b>	84"

Kitchens

Doors

Kitchen Accessories

Hinges

Drawer Slides

Plywood Melamine

Veneer Edgebanding

Laminate

Solid Surface

Closets

Furniture Hardware

Pulls & Knobs

Lighting

Grommets

Locks, Lock Systems

Molding, Carvings

Tools

Adhesives Solvents Abrasives

Chemicals Staples Screws

## High Power 3 Watt LED

Kitchens

Doors

Kitchen Accessories

Hinges

Drawer Slides

Plywood Melamine

Veneer Edgebanding

Laminate

Solid Surface

Closets

Furniture Hardware

Pulls & Knobs

Lighting

Grommets

Locks, Lock Systems

Molding, Carvings

Tools

Adhesives Solvents Abrasives

Chemicals Staples Screws

- Low Profile Design
- High Power Led Bulbs For Better Light Output
- 3 X 1 Watt High Power Bulbs
- Available In Daylight
- Virtually No Heat
- No UV Rays
- Excellent For All Types Of Lighting Requirements

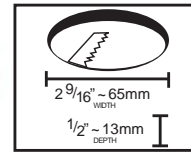

### HIGH POWER L.E.D. 3 LIGHT KIT

FIXTURE	COLOR FINISH	DIA OVERALL	THICKNESS OVERALL	LUMENS	BULB LIFE HOURS	CRI	COLOR TEMP	WATTAGE	VOLTAGE	BEAM SPREAD	UV RATING	HEAT SINK
41-934D	SATIN CHROME	78mm	17mm	300	30,000	80	5000-6000K	3 X 1W	12V DC	120°	Free	Alu.

Power Supply & Extension Cords Sold Separately

#### REQUIRED COMPONENTS



**MALE / MALE CONNECTOR**  
Item Number **41-506**

**POWER SUPPLY**  
Item Number **41-514**  
Input: 350mA Constant Current  
Output: 30v 350mA  
Connect up to 6 Lights

#### OPTIONAL ACCESSORIES



#### EXTENSION

ORDER #	SIZE
41-500	24"
41-502	36"
41-504	84"

# Lighting

## LED Swivel Display Light

- 1 WATT HIGH POWER
- COLOR TEMP 6000K
- SWIVEL HEAD
- BRUSHED CHROME FINISH



Ideal For Displays, Showcases, Store Fixtures, Museums And Retail Applications. Low Energy Consumption, Rated At 40,000 Hours, Easily Adjustable, Easy Installation.

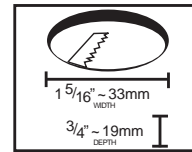

CUT-OUT SIZE

### LED SWIVEL DISPLAY LIGHT

FIXTURE	COLOR FINISH	ANGLE	COLOR TEMP	WATTS PER LED	TOTAL WATTS	LED NUMBER	LUMEN	INPUT
41-830	BRUSHED CHROME	60°	6000K	1W	1W	1	100	350mA Constant Current

#### REQUIRED COMPONENTS



MALE / MALE CONNECTOR  
Item Number 41-506

**POWER SUPPLY**  
Item Number 41-514  
Input: 350mA Constant Current  
Output: 30v 350mA  
Connect up to 6 Lights

#### OPTIONAL ACCESSORIES



##### EXTENSION

ORDER #	SIZE
41-500	24"
41-502	36"
41-504	84"

Kitchens

Doors

Kitchen Accessories

Hinges

Drawer Slides

Plywood Melamine

Veneer Edgebanding

Laminate

Solid Surface

Closets

Furniture Hardware

Pulls & Knobs

Lighting

Grommets

Locks, Lock Systems

Molding, Carvings

Tools

Adhesives Solvents Abrasives

Chemicals Staples Screws

## High Power LED Puck Light

- 3 x 1W High Power *LED*S
- Power Supply Included
- Extremely Long Life (Over 50,000 Hours)
- Virtually No Heat Emissions
- Low Energy Consumption



### HIGH POWER *L.E.D.* PUCK LIGHT

FIXTURE	COLOR / FINISH	DIA OVERALL	THICKNESS OVERALL	LUMENS	BULB LIFE	COLOR TEMP	WATTAGE	VOLTAGE	BEAM SPREAD	UV RATING	HEAT SINK
41-310	STAINLESS STEEL	68mm	23mm	300	50,000 Hours	5000-6000K	3 X 1W	12v DC	60°	Free	Zinc

### CABINET AND DISPLAY LIGHTING

- UV free
- Heat free
- Smart "T" lens
- 12V low voltage
- Energy saving (only 3W)
- Extremely long life
- Easy install - just plug in
- Hi-lumen output - high power LED
- The future of kitchens, garages, book cases, bathrooms, work stations, computer desks, entertainment centers
- Surface and recessed mounting



#### Extension Cord (Sold Separately)



ORDER #	SIZE
41-500	24"
41-502	36"
41-504	84"



#### Use for 3 Light Kit Option

Item Number 41-514  
 Input: CV 100~240v  
 Output: 30v 350mA  
 Connect up to 3 Lights

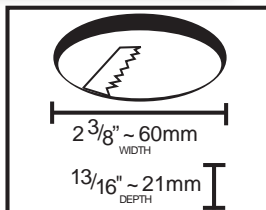

**CUT-OUT SIZE**

Kitchens

Doors

Kitchen Accessories

Hinges

Drawer Slides

Plywood Melamine

Veneer Edgebanding

Laminate

Solid Surface

Closets

Furniture Hardware

Pulls & Knobs

Lighting

Grommets

Locks, Lock Systems

Molding, Carvings

Tools

Adhesives Solvents Abrasives

Chemicals Staples Screws

## High Power LED Swivel Light

- 3 Watt Light: 3 X 1w High Power Led
- Power Supply Included
- Extremely Long Life (Over 50,000 Hours)
- Virtually No Heat Emissions
- Low Energy Consumption

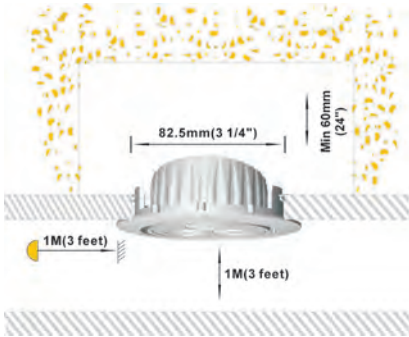

- 45° Maximum swivel
- Overall diameter 3-1/2"
- Cut-out size 3-1/4"
- Minimum height 1-3/8"



### Features:

- 5 year (50,000 hour) bulb life
- Low voltage (3 watt)
- Low temperature (cool to the touch)
- Transformer included



Antique Brass  
**41-320**



Brass  
**41-322**



Chrome  
**41-324**



Black  
**41-326**



White  
**41-328**



Brushed Chrome  
**41-330**

### HIGH POWER L.E.D. SWIVEL LIGHT

FIXTURE	COLOR / FINISH	DIA OVERALL	OVERALL THICKNESS	LUMENS	BULB LIFE	COLOR TEMP	WATTAGE	VOLTAGE	BEAM SPREAD	UV RATING	HEAT SINK
<b>41-328</b>	WHITE	89MM	34MM	300	50,000 Hours	5000-6000K	3 X 1W	12v DC	60 Degree	Free	Zinc
<b>41-326</b>	BLACK	89MM	34MM	300	50,000 Hours	5000-6000K	3 X 1W	12v DC	60 Degree	Free	Zinc
<b>41-330</b>	BRUSHED CHROME	89MM	34MM	300	50,000 Hours	5000-6000K	3 X 1W	12v DC	60 Degree	Free	Zinc
<b>41-324</b>	POLISHED CHROME	89MM	34MM	300	50,000 Hours	5000-6000K	3 X 1W	12v DC	60 Degree	Free	Zinc
<b>41-322</b>	POLISHED BRASS	89MM	34MM	300	50,000 Hours	5000-6000K	3 X 1W	12v DC	60 Degree	Free	Zinc
<b>41-320</b>	ANTIQUE BRASS	89MM	34MM	300	50,000 Hours	5000-6000K	3 X 1W	12v DC	60 Degree	Free	Zinc

Extension Cords Sold Separately



For 3 Light Kit Order  
Item Number **41-514**  
Input: AC 100~240v  
Output: 30v 300 mA



### EXTENSION

ORDER #	SIZE
<b>41-500</b>	24"
<b>41-502</b>	36"
<b>41-504</b>	84"

Kitchens

Doors

Kitchen  
Accessories

Hinges

Drawer  
Slides

Plywood  
Melamine

Veneer  
Edgebanding

Laminate

Solid  
Surface

Closets

Furniture  
Hardware

Pulls  
&  
Knobs

Lighting

Grommets

Locks,  
Lock  
Systems

Molding,  
Carvings

Tools

Adhesives  
Solvents  
Abrasives

Chemicals  
Staples  
Screws

## 120V LED Plastic Puck Light

- 2.5 Watt 120v Plastic LED Puck Light
- Linkable Up To 30 Lights
- 3 Color Option
- Easy To Install
- Color Temp 3000k ~ 6000k

**DIMMABLE**

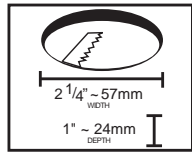

**CUT-OUT SIZE**



PART NUMBER	COLOR FINISH	DIA OVERALL	THICKNESS	COLOR TEMP	TOTAL LUMEN	CRI	LED NUMBER	WATTAGE	INPUT	CERTIFICATION
<b>41-660</b>	White	70mm	24mm	3000K	120	80	10	2.5W	120V AC	cETLus
<b>41-662</b>	Black	70mm	24mm	3000K	120	80	10	2.5W	120V AC	cETLus
<b>41-664</b>	Matted Chrome	70mm	24mm	3000K	120	80	10	2.5W	120V AC	cETLus
<b>41-680</b>	White	70mm	24mm	6000K	130	80	10	2.5W	120V AC	cETLus
<b>41-682</b>	Black	70mm	24mm	6000K	130	80	10	2.5W	120V AC	cETLus
<b>41-684</b>	Matted Chrome	70mm	24mm	6000K	130	80	10	2.5W	120V AC	cETLus



**41-980**  
10' Black (Sold separately)



**41-981**  
10' White (Sold separately)



WHITE EXTENSION	
ORDER #	SIZE
<b>H5.91301-010</b>	4"
<b>41-982</b>	36"

# Lighting

## 120V Dimmable LED Metal Puck Light

- 2.5 Watt 120v Metal LED Puck Light
  - Linkable Up To 30 Lights
    - 3 Color Option
    - Easy To Install
  - Color Temp 3000k ~ 6000k

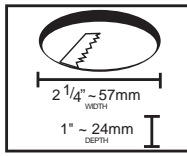

CUT-OUT SIZE



U. L. LISTED

PART NUMBER	COLOR FINISH	DIA OVERALL	THICKNESS	COLOR TEMP	TOTAL LUMEN	CRI	LED NUMBER	WATTAGE	INPUT	CERTIFICATION
41-940	White	70mm	24mm	3000K	120	80	10	2.5W	120V AC	cETLus
41-942	Black	70mm	24mm	3000K	120	80	10	2.5W	120V AC	cETLus
41-946	Matted Chrome	70mm	24mm	3000K	120	80	10	2.5W	120V AC	cETLus
41-930	White	70mm	24mm	6000K	130	80	10	2.5W	120V AC	cETLus
41-931	Black	70mm	24mm	6000K	130	80	10	2.5W	120V AC	cETLus
41-932	Matted Chrome	70mm	24mm	6000K	130	80	10	2.5W	120V AC	cETLus



WHITE EXTENSION

ORDER #	SIZE
H5.91301-010	4"
41-982	36"



Black



Matte Chrome



41-980

10' Black (Sold separately)



41-981

10' White (Sold separately)

Kitchens

Doors

Kitchen Accessories

Hinges

Drawer Slides

Plywood Melamine

Veneer Edgebanding

Laminate

Solid Surface

Closets

Furniture Hardware

Pulls & Knobs

Lighting

Grommets

Locks, Lock Systems

Molding, Carvings

Tools

Adhesives Solvents Abrasives

Chemicals Staples Screws



## 6" Retrofit Recessed Ceiling Light

Kitchens

Doors

### 6" LED Retrofit Recessed Economy Ceiling Light with Acrylic Diffuser

Kitchen Accessories

Hinges

Drawer Slides

Plywood Melamine

Veneer Edgebanding

Laminate

Solid Surface

Closets

Furniture Hardware

Pulls & Knobs

Lighting

Grommets

Locks, Lock Systems

Molding, Carvings

Tools

Adhesives Solvents Abrasives

Chemicals Staples Screws



**DIMMABLE**

Item Number: **41-720**

- Dimmable
- 120v
- White Acrylic Diffuser
- Easy To Install



**DIMMABLE**

Item Number: **41-722**

- Dimmable
- 120v
- Easy To Install
- ETL / FCC And Energy Star Certified

#### 6" DIMMABLE LED RETROFIT RECESSED CEILING LIGHT

FIXTURE	COLOR FINISH	BEAM ANGLE	COLOR TEMP	WATTS PER LED	TOTAL WATTS	LED NUMBER	LUMEN PER WATT	CRI	VOLTAGE	LUMEN	INPUT
<b>41-722</b>	WHITE	120°	3300K	3W	15W	5	46	82	120v 60Hz	690	.128mA Constant Current

#### 6" DIMMABLE LED RETROFIT RECESSED CEILING LIGHT

FIXTURE	COLOR FINISH	BEAM ANGLE	COLOR TEMP	WATTS PER LED	TOTAL WATTS	LED NUMBER	LUMEN PER WATT	CRI	VOLTAGE	LUMEN	INPUT
<b>41-720</b>	White	120°	3300K	.5W	16W	40	56	80	120v 60Hz	900	120v

## 6" Retrofit Recessed Ceiling Light

### PARTS:

Remove fixture and mounting package from box and make sure that all parts are not missing by referencing illustrations below.

### INSTALLATIONS:

1. DISCONNECT POWER AT THE CIRCUIT BREAKER.
2. If necessary, remove the LIGHT BULB and EXISTING TRIM from the RECESSED LIGHT FIXTURE. Typically, this is done by grabbing the outer edge of the EXISTING TRIM and pulling downward. This is then followed by detaching its mounting mechanisms, such as the spring-loaded BUTTERFLY WINGS, from the LIGHT FIXTURE.

Your EXISTING TRIM may have a different removal method. Please refer to its instructions if you are unsure.

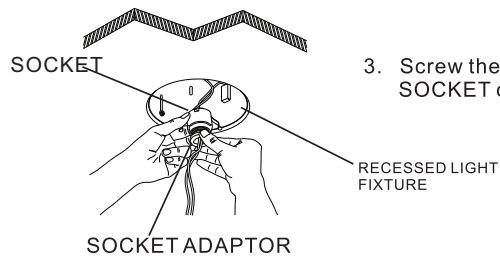

3. Screw the SOCKET ADAPTOR of the LED RETROFIT TRIM into the SOCKET of the RECESSED LIGHT FIXTURE.

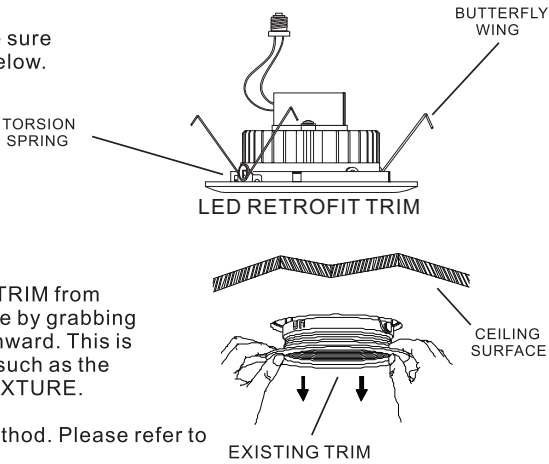

4. NOTE: This product is provided with TORSION SPRINGS, used to secure and raise it into a RECESSED LIGHT FIXTURES will have varying constructions. Some fixtures will be provided with RECEIVING SLOTS. Some will be provided with RECEIVING CLIPS.

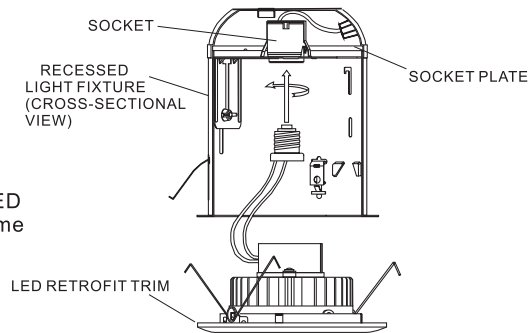

Follow the instructions below appropriate to the construction of your fixture.

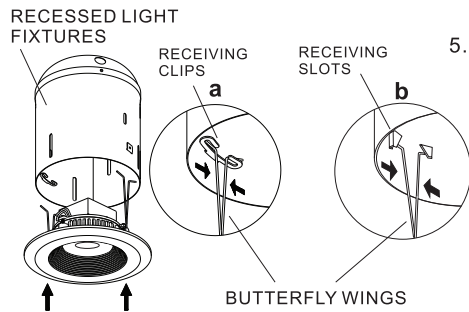

5. Squeeze the BUTTERFLY WINGS of each TORSION SPRING together. Raise the LED RETROFIT TRIM up to the RECESSED LIGHT FIXTURE.
  - a. **RECEIVING CLIPS METHOD** Squeeze the BUTTERFLY WINGS into the provided RECEIVING CLIPS of the RECESSED LIGHT FIXTURES, as shown left. Release the BUTTERFLY WINGS.
  - b. **RECEIVING SLOTS METHOD** Insert the ends of the BUTTERFLY WINGS into the provided RECEIVING SLOTS of the RECESSED LIGHT FIXTURES, as shown left. Release the BUTTERFLY WINGS.

6. Push the LED RETROFIT TRIM into the RECESSED LIGHT FIXTURE, allowing the TORSION SPRINGS to pull the LED TRIM up into the RECESSED LIGHT FIXTURE. Continue to push the LED TRIM until its outer edge is flush against the CEILING SURFACE.
7. RESTORE POWER AT THE CIRCUIT BREAKER. Turn on the wall switch.

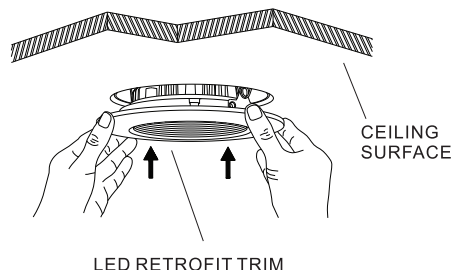

Kitchens

Doors

Kitchen Accessories

Hinges

Drawer Slides

Plywood Melamine

Veneer Edgbanding

Laminate

Solid Surface

Closets

Furniture Hardware

Pulls & Knobs

Lighting

Grommets

Locks, Lock Systems

Molding, Carvings

Tools

Adhesives Solvents Abrasives

Chemicals Staples Screws

# Lighting

## High Power LED 110v Security Lighting

- Clean Look Blends Seamlessly With Architectural Elements
  - Indoor/Outdoor
  - Energy Efficient Light Best For Security
- Significantly Longer Life Leads To Reduced Maintenance Costs
  - Choice Of Mounting Options To Meet A Variety Of Architectural Applications
  - Light Weight Compact Design For Easy Installation
- With 360°/180° Powder Coated White Steel Mounting Bracket
  - With 60° Beam Angle
- ETL Recognized For Wet Locations

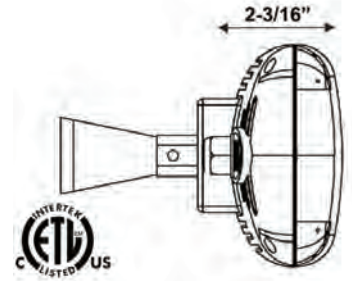
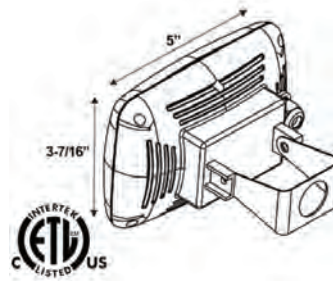

### MATERIALS / CONSTRUCTION

- **High-Impact, Heat-Resistant Lens:** Polycarbonate Shield Designed to Distribute Light Evenly along Building Front
- **Die-Cast Aluminum Housing:** One-Piece, Hinged Back Provides Strong Support and Maximum Heat Dissipation
- **High Power-Factor Ballast:** Constant-Current Power Supply
- **Weatherproof:** One-Piece Silicone Gasket Completely Seals Housing and Lens Frame, Locking out Moisture and Dust. Lens Frame Secured to Housing with 6 Stainless-Steel Screws.
- **Easy Mounting:** Top- and Side-Entry 1/2" Threaded Hub for Thru-Wire Installation. Easily Installs over Standard 4" Box.
- **Durable, All-Weather Architectural Finish**

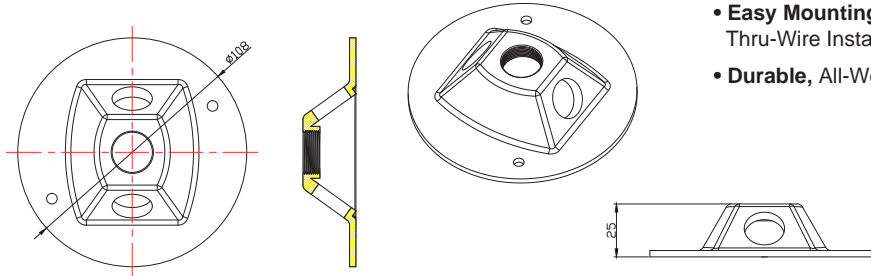

### 9 WATT LED OUTDOOR SECURITY LIGHT

FIXTURE	COLOR / FINISH	LUMENS	BULB LIFE	CRI	COLOR TEMP	WATTAGE	VOLTAGE	BEAM SPREAD	UV RATING	HEAT SINK
LED-006S-W-110V	WHITE	600	50,000 Hours	80	6000K	6w	110-120v AC	60°	Free	Aluminum

## High Power LED 110V Landscape Lighting

- IP 67 Rated
- Clean Look Blends Seamlessly With Architectural Elements
  - Indoor/Outdoor
- Energy Efficient Light Best For Landscape or Gardens
- Significantly Longer Life Leads To Reduced Maintenance Costs
  - Choice Of Mounting Options To Meet A Variety Of Architectural Applications
- Light Weight Compact Design For Easy Installation
  - With 360°/180° Steel Mounting Bracket
  - With 60° Beam Angle
  - ETL Recognized For Wet Locations

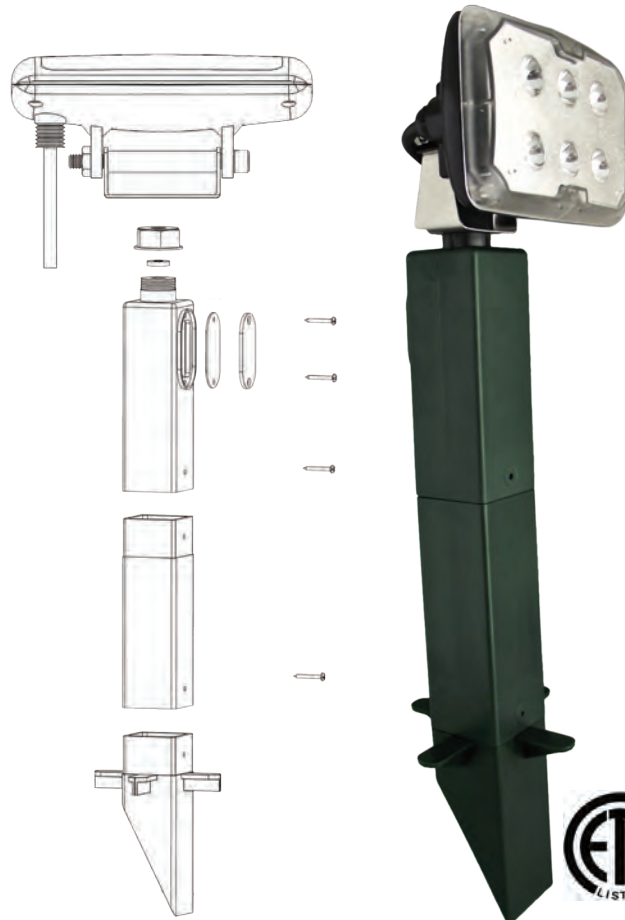
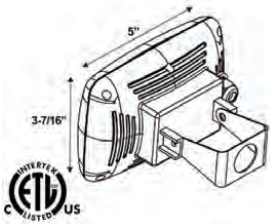

### MATERIALS / CONSTRUCTION

- **High-Impact, Heat-Resistant Lens:** Polycarbonate Shield Designed to Distribute Light Evenly along Building Front
- **Die-Cast Aluminum Housing:** One-Piece, Hinged Back Provides Strong Support and Maximum Heat Dissipation
- **High Power-Factor Ballast:** Constant-Current Power Supply
- **Weatherproof:** One-Piece Silicone Gasket Completely Seals Housing and Lens Frame, Locking out Moisture and Dust. Lens Frame Secured to Housing with 6 Stainless-Steel Screws.
- **Easy Mounting:** Top- and Side-Entry 1/2" Threaded Hub for Thru-Wire Installation. Easily Installs over Standard 4" Box.
- **Durable,** All-Weather Architectural Finish

### 9 WATT LED OUTDOOR FLOOD LIGHT

FIXTURE	COLOR / FINISH	LUMENS	BULB LIFE	CRI	COLOR TEMP	WATTAGE	VOLTAGE	BEAM SPREAD	UV RATING	HEAT SINK
<b>LED-006L-B-110V</b>	BLACK	600	50,000 Hours	80	6000K	6w	110~120v AC	60°	Free	Aluminum
<b>LED-006L-G-110V</b>	GREEN	600	50,000 Hours	80	6000K	6w	110~120v AC	60°	Free	Aluminum

- Kitchens
- Doors
- Kitchen Accessories
- Hinges
- Drawer Slides
- Plywood Melamine
- Veneer Edgebanding
- Laminate
- Solid Surface
- Closets
- Furniture Hardware
- Pulls & Knobs
- Lighting
- Grommets
- Locks, Lock Systems
- Molding, Carvings
- Tools
- Adhesives Solvents Abrasives
- Chemicals Staples Screws

# Lighting

## 12 Watt High Power Flood Light

Kitchens

Doors

Kitchen Accessories

Hinges

Drawer Slides

Plywood Melamine

Veneer Edgebanding

Laminate

Solid Surface

Closets

Furniture Hardware

Pulls & Knobs

Lighting

Grommets

Locks, Lock Systems

Molding, Carvings

Tools

Adhesives Solvents Abrasives

Chemicals Staples Screws

- Clean Look Blends Seamlessly With Architectural Elements
  - Indoor/Outdoor
- Energy Efficient Light Best For Industrial & Commercial Buildings
  - Significantly Longer Life Leads To Reduced Maintenance Costs
    - Choice Of Mounting Options To Meet A Variety Of Architectural Applications
  - Light Weight Compact Design For Easy Installation
  - Wide Range Of Power Supply With No Special Ballast Or Transformers Required
- Durable Aluminum Housing With 360°/180° Steel Mounting Bracket
  - ETL Recognized For Wet Locations



### Applications

- Commercial & Residential Security
- Architectural Lighting & Entryway
- Marinas & Docks
- Signage & Landscaping
- Walkways & Boutiques
- Artwork & Galleries
- Maintenance Areas
- Industrial Corridors
- Wash & Rooms
- Storage Areas

### Discreet Day / Night Photo Cell Sensor

- Turns light on at dusk and off at dawn
- Push button actuation on rear of light
- Push once to activate/twice to deactivate photo cell
- 20-second OFF delay
- 60 degree lens



**12W LED Flood Light**  
 Introducing the latest in LED flood/security lighting technology now available for commercial and residential installations and replacements. Our floodlights assure efficient light distribution, with a variety of color filters available to achieve dramatic effects. Free from environmentally hazardous materials and unmatched energy savings. The series is our brightest most compact state-of-the-art design in an Up-Light, Down-Light or Wall-Pack.

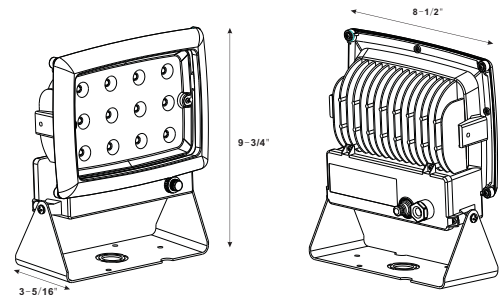

Details: LED-012F-BZ-110V

### 12W FLOOD LIGHT

FIXTURE	COLOR / FINISH	LUMENS	BULB LIFE	CRI	COLOR TEMP	WATTAGE	VOLTAGE	BEAM SPREAD	UV RATING	HEAT SINK
LED-012F-BZ-110V	BRONZE	1000	50,000 Hours	80	6000K	12w	110-277v AC	60°	Free	Metal Housing

## 40 Watt High Power Flood Light

- Clean Look Blends Seamlessly With Architectural Elements
  - Indoor/Outdoor
- Energy Efficient Light Best For Industrial & Commercial Buildings
  - Significantly Longer Life Leads To Reduced Maintenance Costs
    - Choice Of Mounting Options To Meet A Variety Of Architectural Applications
    - Light Weight Compact Design For Easy Installation
    - Wide Range Of Power Supply With No Special Ballast Or Transformers Required
- Durable Aluminum Housing With 360°/180° Steel Mounting Bracket
  - ETL Recognized For Wet Locations

### Applications

- Commercial & Residential Security
- Architectural Lighting & Entryway
- Marinas & Docks
- Signage & Landscaping
- Walkways & Boutiques
- Artwork & Galleries
- Maintenance Areas
- Industrial Corridors
- Wash & Rooms
- Storage Areas

### Discreet Day / Night Photo Cell Sensor

- Turns light on at dusk and off at dawn
- Push button actuation on rear of light
- Push once to activate/twice to deactivate photo cell
- 20-second OFF delay
- 60 degree lens

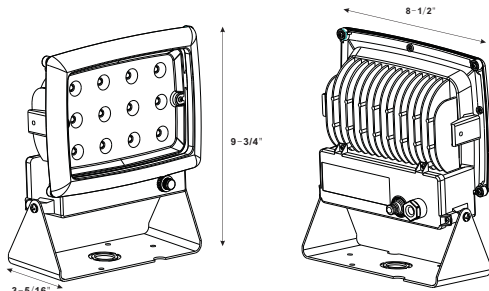

Details: LED-040F-BZ-110V, LED-040F-W-110V



### 40W LED Flood Light

Introducing the latest in LED flood/security lighting technology now available for commercial and residential installations and replacements. Our floodlights assure efficient light distribution, with a variety of color filters available to achieve dramatic effects. Free from environmentally hazardous materials and unmatched energy savings. The series is our brightest most compact state-of-the-art design in an Up-Light, Down-Light or Wall-Pack.

### 40W FLOOD LIGHT

FIXTURE	COLOR / FINISH	LUMENS	BULB LIFE	CRI	COLOR TEMP	WATTAGE	VOLTAGE	BEAM SPREAD	UV RATING	HEAT SINK
LED-040F-BZ-110V	BRONZE	1700	50,000 Hours	78	7638K	40w	110-277v AC	120°	Free	Metal Housing
LED-040F-W-110V	WHITE	1700	50,000 Hours	78	7638K	40w	110-277v AC	120°	Free	Metal Housing

- Kitchens
- Doors
- Kitchen Accessories
- Hinges
- Drawer Slides
- Plywood Melamine
- Veneer Edgebanding
- Laminate
- Solid Surface
- Closets
- Furniture Hardware
- Pulls & Knobs
- Lighting
- Grommets
- Locks, Lock Systems
- Molding, Carvings
- Tools
- Adhesives Solvents Abrasives
- Chemicals Staples Screws

## 60 Watt High Power Flood Light

Kitchens

Doors

Kitchen Accessories

Hinges

Drawer Slides

Plywood Melamine

Veneer Edgebanding

Laminate

Solid Surface

Closets

Furniture Hardware

Pulls & Knobs

Lighting

Grommets

Locks, Lock Systems

Molding, Carvings

Tools

Adhesives Solvents Abrasives

Chemicals Staples Screws

- Clean Look Blends Seamlessly With Architectural Elements
  - Indoor/Outdoor
- Energy Efficient Light Best For Industrial & Commercial Buildings
  - Significantly Longer Life Leads To Reduced Maintenance Costs
    - Choice Of Mounting Options To Meet A Variety Of Architectural Applications
- Light Weight Compact Design For Easy Installation
  - Wide Range Of Power Supply With No Special Ballast Or Transformers Required
- Durable Aluminum Housing With 360°/180° Steel Mounting Bracket
  - ETL Recognized For Wet Locations



### Applications

- Commercial & Residential Security
- Architectural Lighting & Entryway
- Marinas & Docks
- Signage & Landscaping
- Walkways & Boutiques
- Artwork & Galleries
- Maintenance Areas
- Industrial Corridors
- Wash & Rooms
- Storage Areas

### Discreet Day / Night Photo Cell Sensor

- Turns light on at dusk and off at dawn
- Push button actuation on rear of light
- Push once to activate/twice to deactivate photo cell
- 20-second OFF delay
- 60 degree lens



**60W LED Flood Light**  
 Introducing the latest in LED flood/security lighting technology now available for commercial and residential installations and replacements. Our floodlights assure efficient light distribution, with a variety of color filters available to achieve dramatic effects. Free from environmentally hazardous materials and unmatched energy savings. The series is our brightest most compact state-of-the-art design in an Up-Light, Down-Light or Wall-Pack.

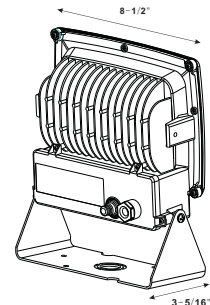
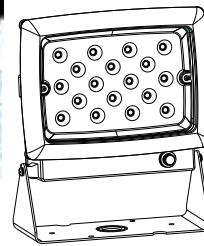

Details: LED-060F-BZ-110V, LED-060F-W-110V

### 60W FLOOD LIGHT

FIXTURE	COLOR / FINISH	LUMENS	BULB LIFE	CRI	COLOR TEMP	WATTAGE	VOLTAGE	BEAM SPREAD	UV RATING	HEAT SINK
LED-060F-BZ-110V	BRONZE	2500	50,000 Hours	80	6000K	60w	110-277v AC	60°	Free	Metal Housing
LED-060F-W-110V	WHITE	2500	50,000 Hours	80	6000K	60w	110-277v AC	60°	Free	Metal Housing

## 90 Watt High Power Flood Light

- Clean Look Blends Seamlessly With Architectural Elements
  - Indoor/Outdoor
- Energy Efficient Light Best For Industrial & Commercial Buildings
  - Significantly Longer Life Leads To Reduced Maintenance Costs
    - Choice Of Mounting Options To Meet A Variety Of Architectural Applications
    - Light Weight Compact Design For Easy Installation
    - Wide Range Of Power Supply With No Special Ballast Or Transformers Required
- Durable Aluminum Housing With 360°/180° Steel Mounting Bracket
  - ETL Recognized For Wet Locations

### Applications

- Commercial & Residential Security
- Architectural Lighting & Entryway
- Marinas & Docks
- Signage & Landscaping
- Walkways & Boutiques
- Artwork & Galleries
- Maintenance Areas
- Industrial Corridors
- Wash Rooms
- Storage Areas

### Discreet Day / Night Photo Cell Sensor

- Turns light on at dusk and off at dawn
- Push button actuation on rear of light
- Push once to activate/twice to deactivate photo cell
- 20-second OFF delay
- 60 degree lens

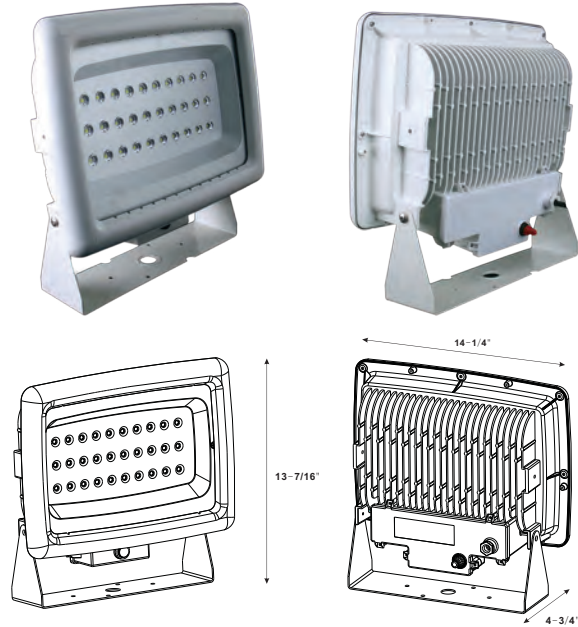

Details: LED-90F-BZ-110V, LED-90F-BZ-110V



### 90W LED Flood Light

Introducing the latest in LED flood/security lighting technology now available for commercial and residential installations and replacements. Our floodlights assure efficient light distribution, with a variety of color filters available to achieve dramatic effects. Free from environmentally hazardous materials and unmatched energy savings. The series is our brightest most compact state-of-the-art design in an Up-Light, Down-Light or Wall-Pack.

### 90W FLOOD LIGHT

FIXTURE	COLOR / FINISH	LUMENS	BULB LIFE	CRI	COLOR TEMP	WATTAGE	VOLTAGE	BEAM SPREAD	UV RATING	HEAT SINK
LED-090F-BZ-110V	BRONZE	4000	50,000 Hours	80	6000K	90w	110-277v AC	90°	Free	Metal Housing
LED-090F-W-110V	WHITE	4000	50,000 Hours	80	6000K	90w	110-277v AC	90°	Free	Metal Housing

- Kitchens
- Doors
- Kitchen Accessories
- Hinges
- Drawer Slides
- Plywood Melamine
- Veneer Edgebanding
- Laminate
- Solid Surface
- Closets
- Furniture Hardware
- Pulls & Knobs
- Lighting
- Grommets
- Locks, Lock Systems
- Molding, Carvings
- Tools
- Adhesives Solvents Abrasives
- Chemicals Staples Screws



## 120 Watt High Power Flood Light

- Clean Look Blends Seamlessly With Architectural Elements
  - Indoor/Outdoor
- Energy Efficient Light Best For Industrial & Commercial Buildings
  - Significantly Longer Life Leads To Reduced Maintenance Costs
    - Choice Of Mounting Options To Meet A Variety Of Architectural Applications
  - Light Weight Compact Design For Easy Installation
  - Wide Range Of Power Supply With No Special Ballast Or Transformers Required
- Durable Aluminum Housing With 360°/180° Steel Mounting Bracket
  - ETL Recognized For Wet Locations



### Applications

- Commercial & Residential Security
- Architectural Lighting & Entryway
- Marinas & Docks
- Signage & Landscaping
- Walkways & Boutiques
- Artwork & Galleries
- Maintenance Areas
- Industrial Corridors
- Wash Rooms
- Storage Areas

### Discreet Day / Night Photo Cell Sensor

- Turns light on at dusk and off at dawn
- Push button actuation on rear of light
- Push once to activate/twice to deactivate photo cell
- 20-second OFF delay
- 60 degree lens

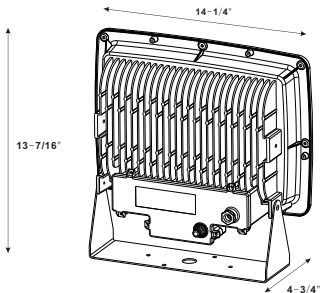
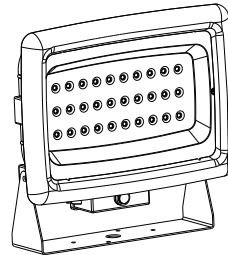

Details: LED-120F-BZ-110V, LED-120F-W-110V

### 120W LED Flood Light

Introducing the latest in LED flood/security lighting technology now available for commercial and residential installations and replacements. Our floodlights assure efficient light distribution, with a variety of color filters available to achieve dramatic effects. Free from environmentally hazardous materials and unmatched energy savings. The series is our brightest most compact state-of-the-art design in an Up-Light, Down-Light or Wall-Pack.

### 120W FLOOD LIGHT

FIXTURE	COLOR / FINISH	LUMENS	BULB LIFE	CRI	COLOR TEMP	WATTAGE	VOLTAGE	BEAM SPREAD	UV RATING	HEAT SINK
LED-120F-BZ-110V	BRONZE	5000	50,000 Hours	80	6000K	120w	110-277v AC	90°	Free	Metal Housing
LED-120F-W-110V	WHITE	5000	50,000 Hours	80	6000K	120w	110-277v AC	90°	Free	Metal Housing

Kitchens

Doors

Kitchen Accessories

Hinges

Drawer Slides

Plywood Melamine

Veneer Edgebanding

Laminate

Solid Surface

Closets

Furniture Hardware

Pulls & Knobs

Lighting

Grommets

Locks, Lock Systems

Molding, Carvings

Tools

Adhesives Solvents Abrasives

Chemicals Staples Screws

## 15 Watt Wall Pack

- 15-Watt High Output LEDs
- Constant Current Driver, Class 2 Power Supply @ 110-277v Ac
- Replaces 100 Watt Qh Lamp
- Chromatically Stable 5700k
  - Cri Of 68
- Low-Draw .13 Amp @ 110v
  - Lm80 Tested
  - Waterproof
  - ETL - Listed
  - Ip66 Rated
- Concealed Fasteners
- Traditional clamshell design for standard installation
  - Dark Sky compliant



**\* Material Characteristics \***

- Heat Sunked Cast Aluminum Housing
- Chip And Fade Resistant Powder-Coat Finish
- Cold Weather-Resistant To - 40°F

**Color Finishes**

- LED-WP-15BRZ - Bronze
- LED-WP-15WHI - White

**5 Year Limited Warranty**



VOLTAGE	WATTAGE	LUMENS
110V ~277V AC	15 Watt	1400
DRAW	IP RATING	LIGHT COLOR
<.13 amp @ 110V	IP66	5700°K
DLC APPROVED	ETL LISTED	PART COLOR
YES	YES	BRONZE / WHITE

Kitchens

Doors

Kitchen Accessories

Hinges

Drawer Slides

Plywood Melamine

Veneer Edgebanding

Laminate

Solid Surface

Closets

Furniture Hardware

Pulls & Knobs

Lighting

Grommets

Locks, Lock Systems

Molding, Carvings

Tools

Adhesives Solvents Abrasives

Chemicals Staples Screws

# Lighting

## 35 Watt Wall Pack

- 35-Watt High Output LEDs
- Constant Current Driver, Class 2 Power Supply @ 110-277v Ac
- Replaces 175 Watt Mh Lamp
- Chromatically Stable 5700k
  - Cri Of 68
- Low-Draw .30 Amp @ 110v
  - Lm80 Tested
  - Waterproof
  - ETL - Listed
  - Ip66 Rated
- Concealed Fasteners
- Traditional Clamshell Design For Standard Installation
- Dark Sky Compliant

### \* Material Characteristics \*

- Heat Sunked Cast Aluminum Housing
- Chip And Fade Resistant Powder-Coat Finish
- Cold Weather-Resistant To - 40°F

### Color Finishes

- LED-Wp-35brz - Bronze
- LED-Wp-35whi - White

5 Year Limited Warranty

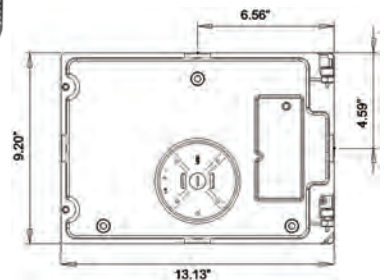

VOLTAGE	WATTAGE	LUMENS
110V~277V AC	35 Watt	3000
DRAW	IP RATING	LIGHT COLOR
<.30 amp @ 110V	IP66	5700°K
DLC APPROVED	ETL LISTED	PART COLOR
YES	YES	BRONZE / WHITE

Kitchens

Doors

Kitchen Accessories

Hinges

Drawer Slides

Plywood Melamine

Veneer Edgebanding

Laminate

Solid Surface

Closets

Furniture Hardware

Pulls & Knobs

Lighting

Grommets

Locks, Lock Systems

Molding, Carvings

Tools

Adhesives Solvents Abrasives

Chemicals Staples Screws

# Lighting

## 40 Watt Wall Pack

- 40-Watt high output LEDs
- Constant current driver, class 2 power supply @ 110-277V AC
  - Replaces 175 Watt MH lamp
- Chromatically stable 5700K; CRI of 75.7
  - Low-draw .30 AMP @ 110V
    - LM80 Tested
    - Waterproof
    - ETL - Listed
    - IP66 Rated
  - Concealed fasteners
- Traditional clamshell design for standard installation
  - Dark Sky compliant



### \* MATERIAL CHARACTERISTICS \*

- Heat Sunked Cast Aluminum Housing
- Chip And Fade Resistant Powder-Coat Finish
- Cold Weather-Resistant To - 40°F

### COLOR FINISHES

- **LED-WP-40BRZ** - Bronze

5 Year Limited Warranty

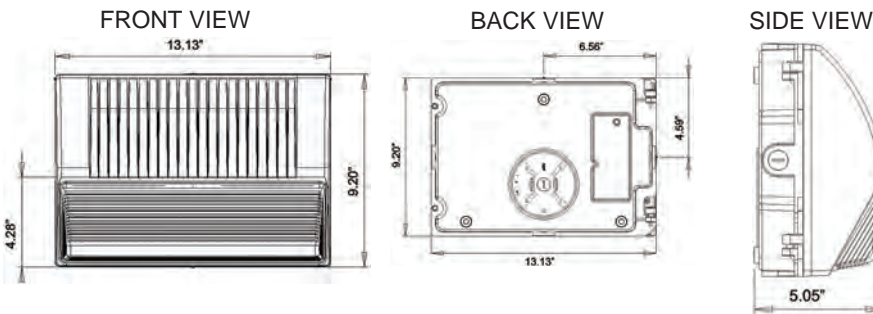

VOLTAGE	WATTAGE	LUMENS
110V~277V AC	40 Watt	3400
DRAW	IP RATING	LIGHT COLOR
<.30 amp @ 110V	IP66	5700°K
DLC APPROVED	ETL LISTED	PART COLOR
YES	YES	BRONZE

- Kitchens
- Doors
- Kitchen Accessories
- Hinges
- Drawer Slides
- Plywood Melamine
- Veneer Edgebanding
- Laminate
- Solid Surface
- Closets
- Furniture Hardware
- Pulls & Knobs
- Lighting
- Grommets
- Locks, Lock Systems
- Molding, Carvings
- Tools
- Adhesives Solvents Abrasives
- Chemicals Staples Screws

# Lighting

## 52 Watt Wall Pack

- 52-Watt High Output LEDs
- Constant Current Driver, Class 2 Power Supply @ 110-277v Ac
- Replaces 250 Watt Mh Lamp
- Chromatically Stable 5700k; Cri Of 84
- Low-Draw .38 Amp @ 110v
  - Lm80 Tested
  - Waterproof
  - ETL - Listed
  - Ip66 Rated
- Concealed Fasteners
- Traditional Clamshell Design For Standard Installation
- Dark Sky Compliant

### \* Material Characteristics \*

- Heat Sunked Cast Aluminum Housing
- Chip And Fade Resistant Powder-Coat Fi
- Cold Weather-Resistant To - 40°F

### Color Finishes

- **LED-Wp-52brz** - Bronze

5 Year Limited Warranty



FRONT VIEW

BACK VIEW

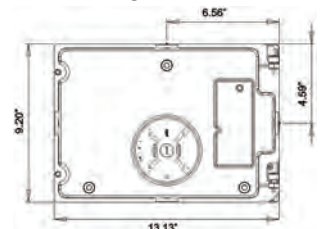
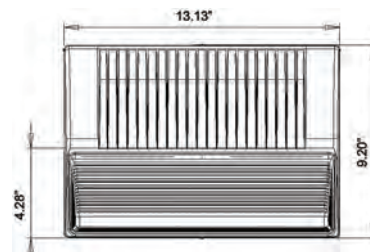

VOLTAGE	WATTAGE	LUMENS
110V_277V AC	52 Watt	4500
DRAW	IP RATING	LIGHT COLOR
<.38 amp @110V	IP66	5700°K
DLC APPROVED	ETL LISTED	PART COLOR
YES	YES	BRONZE

Kitchens

Doors

Kitchen Accessories

Hinges

Drawer Slides

Plywood Melamine

Veneer Edgebanding

Laminate

Solid Surface

Closets

Furniture Hardware

Pulls & Knobs

Lighting

Grommets

Locks, Lock Systems

Molding, Carvings

Tools

Adhesives Solvents Abrasives

Chemicals Staples Screws

# Lighting

## 96 Watt Wall Pack

- 96-Watt High Output LEDs
- Constant Current Driver, Class 2 Power Supply @ 110-277v Ac
  - Replaces 400 Watt Mh Lamp
- Chromatically Stable 5700k; Cri Of 84.9
  - Low-Draw .66 Amp @ 110v
    - Lm80 Tested
    - Waterproof
    - ETL - Listed
    - Ip66 Rated
  - Concealed Fasteners
- Traditional Clamshell Design For Standard Installation
  - Dark Sky Compliant



**\* MATERIAL CHARACTERISTICS \***

- Heat sunked cast aluminum housing
- Chip and fade resistant powder-coat finish
- Cold weather-resistant to - 40°F

**COLOR FINISHES**

- **LED-WP-96BRZ** - Bronze

5 Year Limited Warranty



FRONT VIEW

13.13"

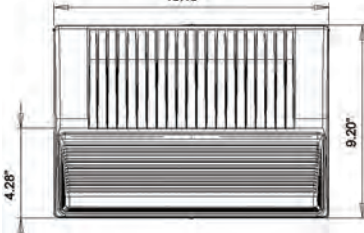

BACK VIEW

6.56"

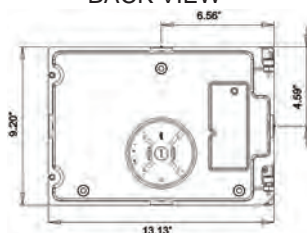

VOLTAGE	WATTAGE	LUMENS
110V ~277V AC	96 Watt	8200
DRAW	IP RATING	LIGHT COLOR
<.66 amp @ 110V	IP66	5700°K
DLC APPROVED	ETL LISTED	PART COLOR
YES	YES	BRONZE

Kitchens

Doors

Kitchen Accessories

Hinges

Drawer Slides

Plywood Melamine

Veneer Edgebanding

Laminate

Solid Surface

Closets

Furniture Hardware

Pulls & Knobs

Lighting

Grommets

Locks, Lock Systems

Molding, Carvings

Tools

Adhesives Solvents Abrasives

Chemicals Staples Screws

# Lighting

## T-8 LED Replacement Bulb

Kitchens

Doors

Kitchen Accessories

Hinges

Drawer Slides

Plywood Melamine

Veneer Edgbanding

Laminate

Solid Surface

Closets

Furniture Hardware

Pulls & Knobs

Lighting

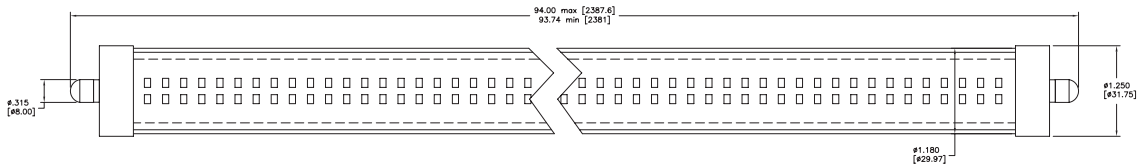

### T-8 FOR UNDER CABINET LIGHT & OTHER APPLICATIONS

FIXTURE	LENGTH	LUMENS	BULB LIFE	CRI	COLOR TEMP	WATTAGE	VOLTAGE	BEAM SPREAD	LED USE	LED QUANTITY	HEAT SINK
<b>41-390</b>	48"	1800	50,000 Hours	78	4500K	18W	120V	120	3528	288 pcs	Alu.



Fluorescent

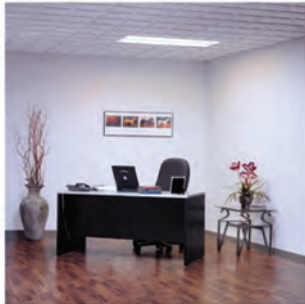

LED

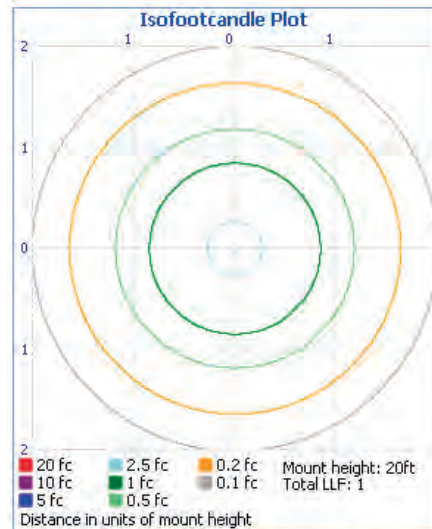
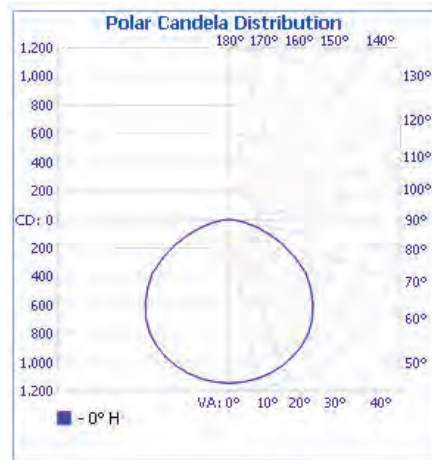

Zonal Lumen Summary			
Zone	Lumens	% Lamp	% Luminaire
0-30	909.9	26.8%	26.8%
0-40	1,514.4	44.5%	44.5%
0-60	2,730.8	80.3%	80.3%
60-90	669.2	19.7%	19.7%
70-100	258.3	7.6%	7.6%
90-120	0	0%	0%
0-90	3,400.0	100%	100%
90-180	0	0%	0%
0-180	3,400.0	100%	100%

Illuminance at a Distance		
	Center Beam FC	Beam Width
3.3R	103.05 fc	10.8ft
6.7R	25.76 fc	21.7ft
10.0R	11.45 fc	32.5ft
13.3R	6.44 fc	43.4ft
16.7R	4.12 fc	54.2ft
20.0R	2.86 fc	65.1ft

Beam Spread: 116.8°

Grommets

Locks, Lock Systems

Molding, Carvings

Tools

Adhesives Solvents Abrasives

Chemicals Staples Screws

## LED Replacement Bulbs

### Features

- Super Bright High Power Led
- Line Voltage 120v – No Transformer Required
- Easy Replacement Using Existing Socket
- Built-In Electronic Driver
- Built-In Spot Lens
- Hi-Lumen Output – Super Bright

### Benefits

- Reduced Power Consumption
- Reduced Maintenance
- Heat Free
- Uv Free

### Applications

- The Future Of Kitchens, Garages, Bookcases, Bathrooms, Work Stations Computer Desks, Entertainment Centers



HIGH POWER 7W LED BULB

ITEM	TYPE	COLOR TEMP	LED NUMBER	LUMEN	INPUT VOLTAGE	WATTAGE	DIMMABLE
H5.12107	FLOOD	5000K	5	650	120V AC/DC	7W	Yes



High Power 6w Led Bulb

ITEM	TYPE	COLOR TEMP	LED NUMBER	LUMEN	BEAM SPREAD	WATTAGE	DIMMABLE
H5.95006CF	GU-10 BULB / FLOOD COOL WHITE	5000K	3	300	120°	6W	Yes
H5.95006WF	GU-10 BULB / FLOOD WARM WHITE	3200K	3	200	120°	6W	Yes

- Kitchens
- Doors
- Kitchen Accessories
- Hinges
- Drawer Slides
- Plywood Melamine
- Veneer Edgebanding
- Laminate
- Solid Surface
- Closets
- Furniture Hardware
- Pulls & Knobs
- Lighting
- Grommets
- Locks, Lock Systems
- Molding, Carvings
- Tools
- Adhesives Solvents Abrasives
- Chemicals Staples Screws



## LED Power Supply & Accessories

- Universal AC Input / Full Range
- Built-In Active PFC Function, PF>0.95
- Protections: Short Circuit / OverLOAD / Over Voltage / Over Temperature
- Forced Air Cooling By Built-In DC Fan
- Built-In Fan On / Off Control
- Led Indicator For Power On
- Fixed Switching Frequency At 90khz



Item Number **H5.00024**



MODEL		Item Number <b>H5.00024</b>	
OUTPUT	DC VOLTAGE	24V	
	RATED CURRENT	10A	
	CURRENT RANGE	0 ~ 10A	
	RATED POWER	240W	
	RIPPLE & NOISE (max.) Note.2	150mVp-p	
	VOLTAGE ADJ. RANGE	20 ~ 28V	
	VOLTAGE TOLERANCE Note.3	±1.0%	
	LINE REGULATION	±0.2%	
	LOAD REGULATION	±0.5%	
	SETUP, RISE TIME	800ms, 50ms/230VAC    1500ms, 50ms/115VAC at full load	
HOLD UP TIME (Typ.)	20ms/230VAC    20ms/115VAC at full load		
INPUT	VOLTAGE RANGE Note.5	88 ~ 264VAC    124 ~ 370VDC	
	FREQUENCY RANGE	47 ~ 63Hz	
	POWER FACTOR (Typ.)	PF>0.95/230VAC    PF>0.98/115VAC at full load	
	EFFICIENCY (Typ.)	87%	
	AC CURRENT (Typ.)	3.6A/115VAC    1.8A/230VAC	
	INRUSH CURRENT (Typ.)	25A/115VAC    40A/230VAC	
PROTECTION	LEAKAGE CURRENT	<2mA / 240VAC	
	OVERLOAD	105 ~ 135% rated output power Protection type : Hiccup mode, recovers automatically after fault condition is removed	
	OVER VOLTAGE	29.5 ~ 35V Protection type : Shut down o/p voltage, re-power on to recover	
FUNCTION	OVER TEMPERATURE	90°C ±5°C (5V,7.5V), 85°C ±5°C (12V,15V,24V,30V,48V) (TSW1 : detect on heatsink of power transistor) Protection type : Shut down o/p voltage, recovers automatically after temperature goes down	
	FAN CONTROL	RTH2 ≥ 40°C FAN ON, ≤ 35°C FAN OFF (Typ.)	
ENVIRONMENT	WORKING TEMP.	-20 ~ +70°C (Refer to output load derating curve)	
	WORKING HUMIDITY	20 ~ 90% RH non-condensing	
	STORAGE TEMP., HUMIDITY	-40 ~ +85°C, 10 ~ 95% RH	
	TEMP. COEFFICIENT	±0.03%/°C (0 ~ 50°C)	
	VIBRATION	10 ~ 500Hz, 2G 10min./1cycle, 60min. each along X, Y, Z axes	
SAFETY & EMC (Note 4)	SAFETY STANDARDS	UL60950-1, TUV EN60950-1 approved	
	WITHSTAND VOLTAGE	I/P-O/P:3KVAC    I/P-FG:1.5KVAC    O/P-FG:0.5KVAC	
	ISOLATION RESISTANCE	I/P-O/P, I/P-FG, O/P-FG:100M Ohms / 500VDC / 25°C / 70% RH	
	EMI CONDUCTION & RADIATION	Compliance to EN55022 (CISPR22) Class B	
	HARMONIC CURRENT	Compliance to EN61000-3-2,-3	
OTHERS	EMS IMMUNITY	Compliance to EN61000-4-2,3,4,5,6,8,11; ENV50204, EN55024, light industry level, criteria A	
	MTBF	284K hrs min.    MIL-HDBK-217F (25°C)	
NOTE	DIMENSION	190*93*50mm (L*W*H)	
	PACKING	0.8Kg; 18pcs/15.4Kg/1.04CUFT	
<p>1. All parameters NOT specially mentioned are measured at 230VAC input, rated load and 25°C of ambient temperature.                  2. Ripple &amp; noise are measured at 20MHz of bandwidth by using a 12" twisted pair-wire terminated with a 0.1uf &amp; 47uf parallel capacitor.                  3. Tolerance : includes set up tolerance, line regulation and load regulation.                  4. The power supply is considered a component which will be installed into a final equipment. The final equipment must be re-confirmed that it still meets EMC directives.                  5. Derating may be needed under low input voltages. Please check the derating curve for more details.</p>			

## LED Power Supply & Accessories

- AC Input Range Selectable By Switch
- Protections: Short Circuit / OverLOAD / Over Voltage
- Cooling By Free Air Convection
- Led Indicator For Power On
- 100% Full LOAD Burn-In Test
- High Efficiency, Long Life And High Reliability



Item Number **H5.00012**



MODEL	Item Number <b>H5.00012</b>	
OUTPUT	DC VOLTAGE	12V
	RATED CURRENT	12.5A
	CURRENT RANGE	0 ~ 12.5A
	RATED POWER	150W
	RIPPLE & NOISE (max.) Note.2	120mVp-p
	VOLTAGE ADJ. RANGE	11.4 ~ 13.5V
	VOLTAGE TOLERANCE Note.3	±1.0%
	LINE REGULATION Note.4	±0.5%
	LOAD REGULATION Note.5	±0.5%
	SETUP, RISE TIME Note.7	800ms, 20ms/230VAC    1200ms, 30ms/115VAC at full load
HOLD UP TIME (Typ.)	24ms/230VAC    20ms/115VAC at full load	
INPUT	VOLTAGE RANGE	90 ~ 132VAC / 180 ~ 264VAC selected by switch    254 ~ 373VDC
	FREQUENCY RANGE	47 ~ 63Hz
	EFFICIENCY (Typ.)	83%
	AC CURRENT (Typ.)	3A/115VAC    2A/230VAC
	INRUSH CURRENT (Typ.)	COLD START 45A/230VAC
PROTECTION	OVERLOAD	110 ~ 150% rated output power Protection type : Hiccup mode, recovers automatically after fault condition is removed
	OVER VOLTAGE	13.8 ~ 16.2V Protection type : Hiccup mode, recovers automatically after fault condition is removed
ENVIRONMENT	WORKING TEMP.	-20 ~ +60°C (Refer to output load derating curve)
	WORKING HUMIDITY	20 ~ 90% RH non-condensing
	STORAGE TEMP., HUMIDITY	-40 ~ +85°C, 10 ~ 95% RH
	TEMP. COEFFICIENT	±0.03%/°C (0 ~ 50°C)
SAFETY & EMC (Note 6)	VIBRATION	10 ~ 500Hz, 2G 10min./1cycle, period for 60min. each along X, Y, Z axes
	SAFETY STANDARDS	UL60950-1, TUV EN60950-1, GB4943 approved
	WITHSTAND VOLTAGE	I/P-O/P:3KVAC    I/P-FG:1.5KVAC    O/P-FG:0.5KVAC
	ISOLATION RESISTANCE	I/P-O/P, I/P-FG, O/P-FG:100M Ohms/500VDC 70% RH
	EMI CONDUCTION & RADIATION	Compliance to EN55022 (CISPR22) Class B, GB9254 CLASS B
OTHERS	HARMONIC CURRENT	Compliance to EN61000-3-2,-3, GB17625.1
	EMS IMMUNITY	Compliance to EN61000-4-2, 3, 4, 5, 6, 8, 11, ENV50204, EN55024, EN61000-6-1, heavy industry level, criteria A
	MTBF	433.3Khrs min.    MIL-HDBK-217F (25°C)
NOTE	DIMENSION	199*98*38mm (L*W*H)
	PACKING	0.7Kg; 20pcs/15Kg/0.72CUFT
<p>1. All parameters NOT specially mentioned are measured at 230VAC input, rated load and 25°C of ambient temperature.                  2. Ripple &amp; noise are measured at 20MHz of bandwidth by using a 12" twisted pair-wire terminated with a 0.1uf &amp; 47uf parallel capacitor.                  3. Tolerance : includes set up tolerance, line regulation and load regulation.                  4. Line regulation is measured from low line to high line at rated load.                  5. Load regulation is measured from 0% to 100% rated load.                  6. The power supply is considered a component which will be installed into a final equipment. The final equipment must be re-confirmed that it still meets EMC directives.                  7. Length of set up time is measured at cold first start. Turning ON/OFF the power supply very quickly may lead to increase of the set up time.</p>		

- Kitchens
- Doors
- Kitchen Accessories
- Hinges
- Drawer Slides
- Plywood Melamine
- Veneer Edgebanding
- Laminate
- Solid Surface
- Closets
- Furniture Hardware
- Pulls & Knobs
- Lighting
- Grommets
- Locks, Lock Systems
- Molding, Carvings
- Tools
- Adhesives Solvents Abrasives
- Chemicals Staples Screws

## LED Power Supply & Accessories

- Constant Current Design
- Universal Ac Input / Full Range
- Fully Encapsulated With Ip67 Level
- Withstand 300vac Surge Input For 5 Seconds
- Protections: Short Circuit / Over Current / Over Voltage
- Fully Isolated Plastic Case
- Cooling By Free Air Convection
- UI1310 Class 2 Power Unit
- Pass Lps
- 100% Full LOAD Burn-In Test
- Low Cost, High Reliability
- Suitable For Led Lighting And Moving Sign Applications



Item Number **H5.12025**

LPS IP67 ( for 700mA only ) US ( except for 700mA )

MODEL		
OUTPUT	RATED CURRENT	700mA
	DC VOLTAGE RANGE	9 ~ 48V
	RATED POWER	33.6W
	RIPPLE & NOISE (max.) Note.2	200mVp-p
	VOLTAGE TOLERANCE Note.3	±5.0%
	LINE REGULATION	±1.0%
	LOAD REGULATION	±2.0%
	SETUP, RISE TIME Note.6	500ms, 120ms / 230VAC 500ms, 120ms / 115VAC at full load
HOLD UP TIME (Typ.)	50ms/230VAC 16ms/115VAC at full load	
INPUT	VOLTAGE RANGE Note.4	90 ~ 264VAC 127 ~ 370VDC
	FREQUENCY RANGE	47 ~ 63Hz
	EFFICIENCY (Typ.)	85%
	AC CURRENT	1.1A/115VAC 0.7A/230VAC
	INRUSH CURRENT(max.)	COLD START 30A/115VAC 60A/230VAC
	LEAKAGE CURRENT	0.25mA / 240VAC
PROTECTION	CURRENT LIMIT	±5% rated output current Protection type : Constant current limiting type
	OVER VOLTAGE	50.4 ~ 60V 31.5 ~ 40.5V 27.6 ~ 32.4V Protection type : Shut off o/p voltage, clamping by zener diode
ENVIRONMENT	WORKING TEMP.	-30 ~ +75°C (Refer to output load derating curve)
	WORKING HUMIDITY	20 ~ 90% RH non-condensing
	STORAGE TEMP., HUMIDITY	-40 ~ +80°C, 10 ~ 95% RH
	TEMP. COEFFICIENT	±0.03%/°C (0 ~ 50°C)
	VIBRATION	10 ~ 500Hz, 2G 10min./1cycle, period for 60min. each along X, Y, Z axes
SAFETY & EMC	SAFETY STANDARDS	UL1310 Class 2, CAN/CSA C22.2 No. 223-M91(except for LPC-35-700), IP67 approved ; design refer to TUV EN60950-1, EN61347-2-13
	WITHSTAND VOLTAGE	I/P-O/P:3KVAC
	ISOLATION RESISTANCE	I/P-O/P:>100M Ohms / 500VDC / 25°C / 70% RH
	EMI CONDUCTION & RADIATION	Compliance to EN55022 (CISPR22) Class B
OTHERS	HARMONIC CURRENT	Compliance to EN61000-3-2 Class A, EN61000-3-3
	EMS IMMUNITY	Compliance to EN61000-4-2,3,4,5,6,8,11; ENV50204, EN55024, light industry level, criteria A
	MTBF	743.5Khrs min. MIL-HDBK-217F (25°C)
OTHERS	DIMENSION	148*40*30mm (L*W*H)
	PACKING	0.34Kg; 40pcs/14.6Kg/0.63CUFT
	NOTE	1. All parameters NOT specially mentioned are measured at 230VAC input, rated load and 25°C of ambient temperature. 2. Ripple & noise are measured at 20MHz of bandwidth by using a 12" twisted pair-wire terminated with a 0.1uf & 47uf parallel capacitor. 3. Tolerance : includes set up tolerance, line regulation and load regulation. 4. Derating may be needed under low input voltage. Please check the static characteristics for more details. 5. The power supply is considered as a component that will be operated in combination with final equipment. Since EMC performance will be affected by the complete installation, the final equipment manufacturers must re-qualify EMC Directive on the complete installation again. 6. Length of set up time is measured at first cold start. Turning ON/OFF the power supply may lead to increase of the set up time. 7. In the European market this power supply can be used for LED lighting applications with input power up to 25W. 8. Suitable for indoor use or outdoor use without direct sunlight exposure. Please avoid immerse in the water over 30 minute.

# Lighting

## 120v Xenon Light

- UI Listed
- Includes Diffuser (Frosted) Glass
- Less Heat – Longer Bulb Life
- Linkable Up To 20 Lights
- Sold Individually

FIXTURE	COLOR / FINISH	CUT-OUT	REPLACEMENT BULB	LUMENS	BULB LIFE	COLOR TEMP	WATTAGE	VOLTAGE	BEAM SPREAD	UV RATING	HEAT SINK
41-974	WHITE	2 1/4"	JCD-G8	300	3000 Hours	2900K	20W	120v	N/A	N/A	N/A
41-978	BLACK	2 1/4"	JCD-G8	300	3000 Hours	2900K	20W	120v	N/A	N/A	N/A
41-970	GOLD	2 1/4"	JCD-G8	300	3000 Hours	2900K	20W	120v	N/A	N/A	N/A
41-972	CHROME	2 1/4"	JCD-G8	300	3000 Hours	2900K	20W	120v	N/A	N/A	N/A
41-976	MATTE CHROME	2 1/4"	JCD-G8	300	3000 Hours	2900K	20W	120v	N/A	N/A	N/A
41-980	BLACK	10'	Power Supply (Sold Separately)								
41-981	WHITE	10'	Power Supply (Sold Separately)								

Power-Out Cord 24"



**UL** US  
U.L. LISTED

Power-In Cord 24"



41-980  
10' Black (Sold separately)



41-981  
10' White (Sold separately)

SEE PAGE 358 FOR  
REPLACEMENT BULBS

XENON  
BULB

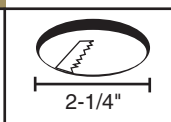
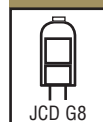

CUT-OUT SIZE

Kitchens

Doors

Kitchen  
Accessories

Hinges

Drawer  
Slides

Plywood  
Melamine

Veneer  
Edgebanding

Laminate

Solid  
Surface

Closets

Furniture  
Hardware

Pulls  
&  
Knobs

Lighting

Grommets

Locks,  
Lock  
Systems

Molding,  
Carvings

Tools

Adhesives  
Solvents  
Abrasives

Chemicals  
Staples  
Screws

# Stainless Steel

Kitchens

Doors

Kitchen Accessories

Hinges

Drawer Slides

Plywood Melamine

Veneer Edgebanding

Laminate

Solid Surface

Closets

Furniture Hardware

Pulls & Knobs

Lighting

Grommets

Locks, Lock Systems

Molding, Carvings

Tools

Adhesives Solvents Abrasives

Chemicals Staples Screws

# Triangle halogen



## Stainless Steel Light

- Low Voltage Halogen 3 Light Kit
- U.L. Listed 60w Transformer with Locking Molex Connectors
- 3 – 20 Watt Bulbs Included



STAINLESS STEEL LIGHT

FIXTURE	COLOR / FINISH	LUMENS	BULB LIFE	COLOR TEMP	WATTAGE	VOLTAGE	BEAM SPREAD	UV RATING	HEAT SINK
41-958	STAINLESS STEEL	300	3000 Hours	2700K	3 x 20w	12v AC	N/A	N/A	N/A

SEE PAGE 358 FOR  
REPLACEMENT  
BULBS

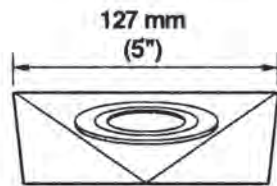
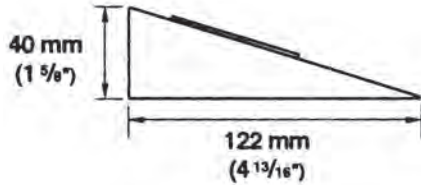

Kitchens

Doors

Kitchen  
Accessories

Hinges

Drawer  
Slides

Plywood  
Melamine

Veneer  
Edgebanding

Laminate

Solid  
Surface

Closets

Furniture  
Hardware

Pulls  
&  
Knobs

Lighting

Grommets

Locks,  
Lock  
Systems

Molding,  
Carvings

Tools

Adhesives  
Solvents  
Abrasives

Chemicals  
Staples  
Screws

## Halogen 3 Light Kit

Kitchens

Doors

Kitchen Accessories

Hinges

Drawer Slides

Plywood Melamine

Veneer Edgebanding

Laminate

Solid Surface

Closets

Furniture Hardware

Pulls & Knobs

Lighting

Grommets

Locks, Lock Systems

Molding, Carvings

Tools

Adhesives Solvents Abrasives

Chemicals Staples Screws

- Safety transformer
- All connecting wiring
- Low voltage
- Transformer included

### Plastic Down Light

FIXTURE	COLOR / FINISH	CUT-OUT	LUMENS	BULB LIFE	COLOR TEMP	WATTAGE	VOLTAGE	BEAM SPREAD	UV RATING	HEAT SINK
<b>41-904</b>	WHITE	2 3/16"	300	3000 Hours	2700K	20w	12v AC	N/A	N/A	N/A
<b>41-906</b>	BLACK	2 3/16"	300	3000 Hours	2700K	20w	12v AC	N/A	N/A	N/A
<b>41-910</b>	GOLD	2 3/16"	300	3000 Hours	2700K	20w	12v AC	N/A	N/A	N/A
<b>41-908</b>	MATTE CHROME	2 3/16"	300	3000 Hours	2700K	20w	12v AC	N/A	N/A	N/A

### Swivel Down Light MR-11

FIXTURE	COLOR / FINISH	CUT-OUT	LUMENS	BULB LIFE	COLOR TEMP	WATTAGE	VOLTAGE	BEAM SPREAD	UV RATING	HEAT SINK
<b>41-676</b>	CHROME	2 3/8"	300	3000 Hours	2700K	20w	12v AC	N/A	N/A	N/A

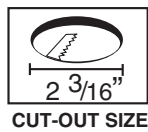

**PLASTIC DOWN LIGHT**

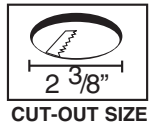

**SWIVEL DOWN LIGHT MR-11**

# Lighting

## 3 X 1W Economy LED Kit

- 3 X 1W LED PUCK LIGHT KIT
- 12V AC POWER SUPPLY INCLUDED
- VIRTUALLY NO HEAT EMISSIONS
- LOW ENERGY CONSUMPTION

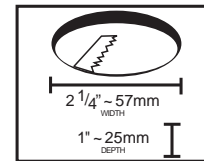

**CUT-OUT SIZE**

Part Number **41-820**

### ECONOMY LED 3 LIGHT KIT

FIXTURE	COLOR FINISH	DIA OVERALL	Thickness OVERALL	LUMENS	BULB LIFE	COLOR TEMP	TOTAL WATTAGE	VOLTAGE	BEAM SPREAD	UV RATING	HEAT SINK
<b>41-822</b>	BLACK	67mm	20mm	70	20,000 Hours	2700-3500K	4x.25w	12v DC	120°	Free	Alu.
<b>41-820</b>	BRUSHED CHROME	67mm	20mm	70	20,000 Hours	2700-3500K	4x.25w	12v DC	120°	Free	Alu.
<b>41-824</b>	CHROME	67mm	20mm	70	20,000 Hours	2700-3500K	4x.25w	12v DC	120°	Free	Alu.

### POWER SUPPLY

Item Number	Input	Output	Amp/mA Watts
<b>41-456</b>	100-240v AC	12v DC	3 amp
<b>41-454</b>	120v AC	12v DC	1 amp
<b>H5.00012</b>	100-240v AC	12v DC	12.5 amp

### Extension Cord (Sold Separately)



ORDER #	SIZE
<b>41-500</b>	24"
<b>41-502</b>	36"
<b>41-504</b>	84"



**41-534 Replacement Bulb**

- Kitchens
- Doors
- Kitchen Accessories
- Hinges
- Drawer Slides
- Plywood Melamine
- Veneer Edgebanding
- Laminate
- Solid Surface
- Closets
- Furniture Hardware
- Pulls & Knobs
- Lighting
- Grommets
- Locks, Lock Systems
- Molding, Carvings
- Tools
- Adhesives Solvents Abrasives
- Chemicals Staples Screws



# Lighting

## 110v GU-10 LED Swivel Light

- No Transformer Required
- Easy Replacement Using Existing Socket
- Extremely Long Life (Over 50,000 Hours)
- Virtually No Heat Emissions
- Low Energy Consumption
- You Must Order Fixture And Bulb



(Bulb Sold Separately)

**DIMMABLE**

### 110V GU-10 Super Bright LED SWIVEL LIGHT FIXTURE FINISHES

FIXTURE	COLOR / FINISH
41-965	WHITE
41-969	BLACK
41-962	ALMOND
41-966	GOLD
41-967	MATTE CHROME
41-968	POLISHED CHROME
41-963	ANTIQUÉ BRASS

### High Power 6w Led Bulb

ITEM	TYPE	COLOR TEMP	LED NUMBER	LUMEN	BEAM SPREAD	WATTAGE	DIMMABLE
H5.95006CF	GU-10 BULB / FLOOD COOL WHITE	5000K	3	300	120°	6W	Yes
H5.95006WF	GU-10 BULB / FLOOD WARM WHITE	3200K	3	200	120°	6W	Yes



Kitchens

Doors

Kitchen Accessories

Hinges

Drawer Slides

Plywood Melamine

Veneer Edgebanding

Laminate

Solid Surface

Closets

Furniture Hardware

Pulls & Knobs

Lighting

Grommets

Locks, Lock Systems

Molding, Carvings

Tools

Adhesives Solvents Abrasives

Chemicals Staples Screws

# Lighting

## 110v GU-10 Halogen Swivel Light

• No Transformer Required

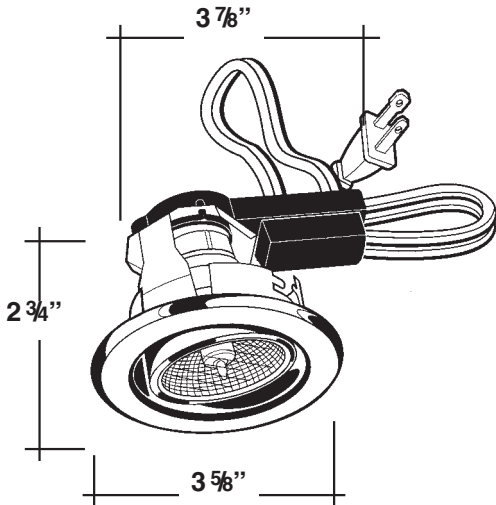

### Mounting Instructions

1. Drill 79 mm (3 1/8") hole in the cabinet.
2. Install butterfly clips as indicated in Detail "X" below. Wing clips should be installed with smaller clip curved to inside of the light rim and larger clip hanging over.
3. Squeeze the larger wing clips through hole as indicated in Detail "Y" below.
4. The smaller butterfly clips press against surface - detail "Z" below.
5. Push on light surface until it fits flush with surface.
6. Ready to plug in wall outlet.

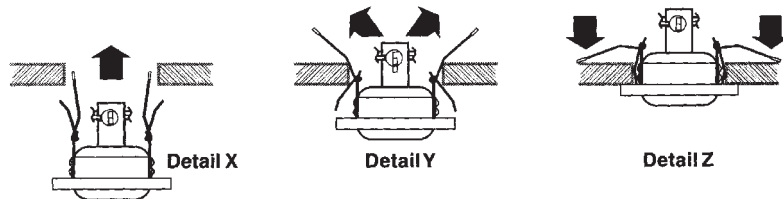

ORDER NUMBER	COLOR / FINISH	CUT-OUT	REPLACEMENT BULB	LUMENS	BULB LIFE	COLOR TEMP	WATTAGE	VOLTAGE
41-965	WHITE	2 7/8"	GU10	525	2,000 Hours	2700K	35w	120v
41-969	BLACK	2 7/8"	GU10	525	2,000 Hours	2700K	35w	120v
41-962	ALMOND	2 7/8"	GU10	525	2,000 Hours	2700K	35w	120v
41-966	GOLD	2 7/8"	GU10	525	2,000 Hours	2700K	35w	120v
41-967	MATTE CHROME	2 7/8"	GU10	525	2,000 Hours	2700K	35w	120v
41-968	CHROME	2 7/8"	GU10	525	2,000 Hours	2700K	35w	120v
41-963	ANTIQU BRASS	2 7/8"	GU10	525	2,000 Hours	2700K	35w	120v

Includes 35W GU10 Bulb

Hole Cut-Out



• Low Voltage Halogen 3 Light Kit  
• U.L. Listed 60w Transformer With Locking Molex Connectors

SEE PAGE 358 FOR REPLACEMENT BULBS

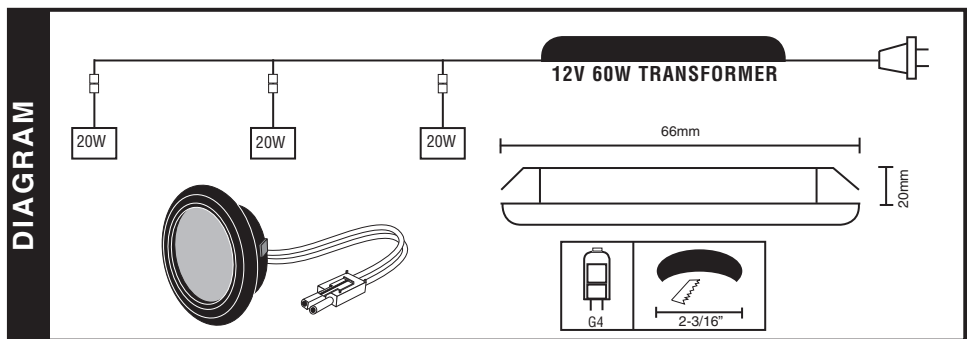

### ALL METAL LIGHTS

FIXTURE	COLOR / FINISH	DIA	LUMENS	BULB LIFE	COLOR TEMP	WATTAGE	VOLTAGE	BEAM SPREAD	UV RATING	HEAT SINK
41-650	GOLD	2-7/16"	300	3000 Hours	2700K	20w	12v AC	N/A	N/A	N/A
41-652	CHROME	2-7/16"	300	3000 Hours	2700K	20w	12v AC	N/A	N/A	N/A
41-646	ANTIQU BRASS	2-7/16"	300	3000 Hours	2700K	20w	12v AC	N/A	N/A	N/A

Kitchens

Doors

Kitchen Accessories

Hinges

Drawer Slides

Plywood Melamine

Veneer Edgebanding

Laminate

Solid Surface

Closets

Furniture Hardware

Pulls & Knobs

Lighting

Grommets

Locks, Lock Systems

Molding, Carvings

Tools

Adhesives Solvents Abrasives

Chemicals Staples Screws

# Lighting

## T-5 Fluorescent Lights

Kitchens

Doors

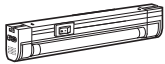

Kitchen Accessories

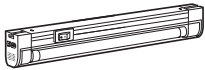

Hinges

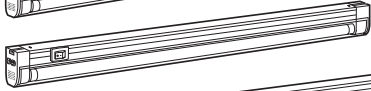

Drawer Slides

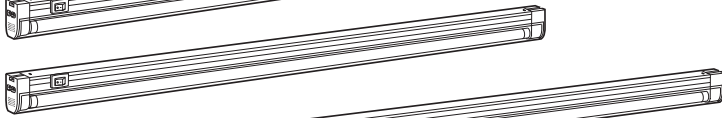

Plywood Melamine

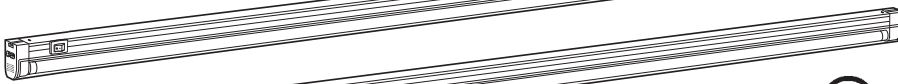

Veneer Edgebanding

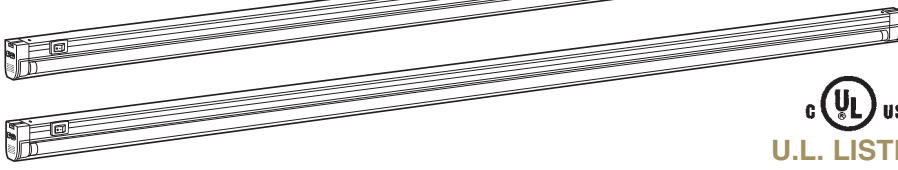

**Metal T5 Fixture Available in 120v and 240v Average Life 30,000 Hours**



**41-362** – 8" Connecting Cord



**41-363** – 24" Connecting Cord



**41-364** – 36" Connecting Cord



**41-366** – 84" Connecting Cord 240v

### T5 FOR UNDER CABINET LIGHT & OTHER APPLICATIONS

	FIXTURE	LENGTH	LUMENS	BULB LIFE	CRI	COLOR TEMP	WATTAGE	VOLTAGE	BEAM SPREAD	UV RATING	HEAT SINK
Solid Surface	<b>41-350</b>	10 1/4"	390	8,000 Hours	82	4500K	6W	120V	N/A	N/A	Alu.
	<b>41-352</b>	12 1/2"	520	8,000 Hours	82	4500K	8W	120V	N/A	N/A	Alu.
	<b>41-354</b>	22 7/8"	840	8,000 Hours	82	4500K	14W	120V	N/A	N/A	Alu.
Closets	<b>41-356</b>	34 11/16"	1365	8,000 Hours	82	4500K	21W	120V	N/A	N/A	Alu.
	<b>41-358</b>	46 1/2"	1820	8,000 Hours	82	4500K	28W	120V	N/A	N/A	Alu.
Furniture Hardware	<b>41-360</b>	58 1/4"	2275	8,000 Hours	82	4500K	35W	120V	N/A	N/A	Alu.
	<b>H5.00614-240</b>	22 7/8"	840	8,000 Hours	82	4500K	14W	240V	N/A	N/A	Alu.
	<b>H5.00628-240</b>	46 1/2"	1820	8,000 Hours	82	4500K	28W	240V	N/A	N/A	Alu.
Pulls & Knobs	<b>H5.92084-240</b>	84" Extension Cord (Sold Separately) See Pages 308-310									
	<b>H5.92000</b>	6' Power Cord (Sold Separately) See Pages 308-310									

### LIGHT SOLD WITH:

- Metal Fixture
- Tri Phosphor Bulb
- Plexiglass Cover
- Power Cord
- Connector
- Styrofoam Protection
- Standard Cool White (also available in warm white and daylight)

Lighting

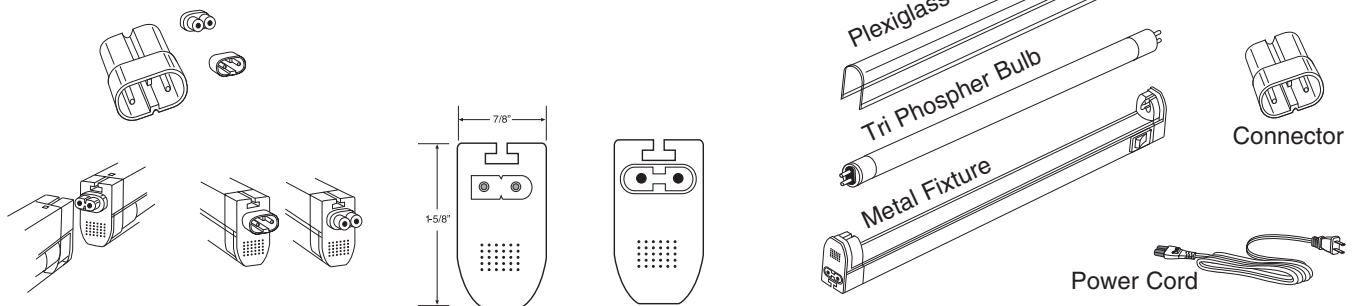

Grommets

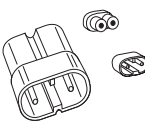

Locks, Lock Systems

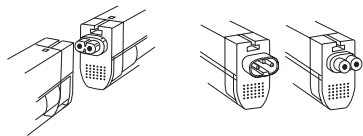

Molding, Carvings

Tools

Adhesives Solvents Abrasives

Chemicals Staples Screws

### Product Features

- Built-in electronic ballast
- Uses standard T5 Bulb 82CRI
- Plexiglass cover included
- Contemporary white metal fixture
- Plug-in modular system permits easy connection for continuous lighting. Easy and simple plug-in installation for power code.
- Energy efficient
- Tri Phosphor bulb is quiet and flicker-free
- Extremely long bulb life, rated 8,000 hours
- Products can be beautifully displayed without damage from high heat levels. Its plexiglass cover makes it a preferred light fixture for food applications.

## Replacement Bulbs

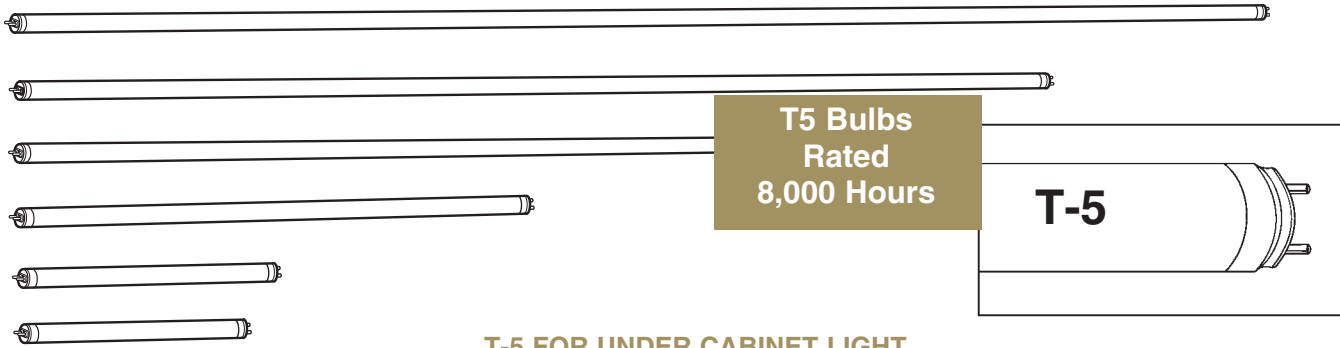

### T-5 FOR UNDER CABINET LIGHT

FIXTURE	COLOR	FOR FIXTURE	LUMENS	BULB LIFE	COLOR TEMP	WATTAGE	VOLTAGE	BEAM SPREAD	UV RATING	HEAT SINK
41-368	COOL WHITE	41-352	520	8,000 Hours	4500K	8W	120V	N/A	N/A	Alu.
41-370	COOL WHITE	41-354	840	8,000 Hours	4500K	14W	120V	N/A	N/A	Alu.
41-372	COOL WHITE	41-356	1365	8,000 Hours	4500K	21W	120V	N/A	N/A	Alu.
41-374	COOL WHITE	41-358	1820	8,000 Hours	4500K	28W	120V	N/A	N/A	Alu.
41-376	COOL WHITE	41-360	2275	8,000 Hours	4500K	35W	120V	N/A	N/A	Alu.
H5.92606C	COOL WHITE	41-350	390	8,000 Hours	4500K	6W	120V	N/A	N/A	Alu.
H5.92606D	DAY LIGHT	41-350	390	8,000 Hours	6500K	6W	120V	N/A	N/A	Alu.
H5.92606W	WARM WHITE	41-350	390	8,000 Hours	2700K	6W	120V	N/A	N/A	Alu.
H5.92608D	DAY LIGHT	41-352	520	8,000 Hours	6500K	8W	120V	N/A	N/A	Alu.
H5.92608W	WARM WHITE	41-352	520	8,000 Hours	2700K	8W	120V	N/A	N/A	Alu.
H5.92614D	DAY LIGHT	41-354	840	8,000 Hours	6500K	14W	120V	N/A	N/A	Alu.
H5.92614W	WARM WHITE	41-354	840	8,000 Hours	2700K	14W	120V	N/A	N/A	Alu.
H5.92621D	DAY LIGHT	41-356	1365	8,000 Hours	6500K	21W	120V	N/A	N/A	Alu.
H5.92621W	WARM WHITE	41-356	1365	8,000 Hours	2700K	21W	120V	N/A	N/A	Alu.
H5.92628D	DAY LIGHT	41-358	1820	8,000 Hours	6500K	28W	120V	N/A	N/A	Alu.
H5.92628W	WARM WHITE	41-358	1820	8,000 Hours	2700K	28W	120V	N/A	N/A	Alu.
H5.92635D	DAY LIGHT	41-360	2275	8,000 Hours	6500K	35W	120V	N/A	N/A	Alu.
H5.92635W	WARM WHITE	41-360	2275	8,000 Hours	2700K	35W	120V	N/A	N/A	Alu.

Kitchens

Doors

Kitchen Accessories

Hinges

Drawer Slides

Plywood Melamine

Veneer Edgebanding

Laminate

Solid Surface

Closets

Furniture Hardware

Pulls & Knobs

Lighting

Grommets

Locks, Lock Systems

Molding, Carvings

Tools

Adhesives Solvents Abrasives

Chemicals Staples Screws

## Replacement Bulbs

**USE WITH  
TRANSFORMERLESS HALOGEN LIGHTS  
Model #41-965**

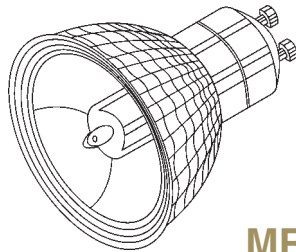

120V

**MR GU10**

Replacement Bulb Model # 41-716 - 35W  
Replacement Bulb Model # 41-718 - 50W

**USE WITH  
SWIVEL HALOGEN EYEBALL LIGHT  
MODEL 38**

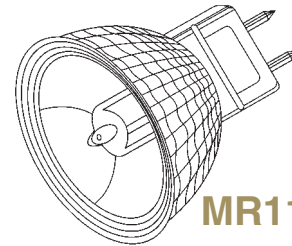

12V

**MR11**

Replacement Bulb Model # 41-544 - 20W

**Use With  
Flush Swivel Halogen Light  
Model 59**

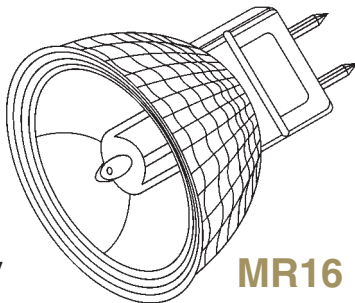

12V

**MR16**

Replacement Bulb Model # 41-540 - 20W  
Replacement Bulb Model # 41-542 - 35W  
Replacement Bulb Model # 41-546 - 50W

### HALOGEN LIGHT

FIXTURE	TYPE	WATTAGE	VOLTAGE
41-544	MR11	20W	12V
41-540	MR16	20W	12V
41-542	MR16	35W	12V
41-546	MR16	50W	12V
FIXTURE	TYPE	WATTAGE	VOLTAGE
41-716	MR GU10	35W	120V
41-718	MR GU10	50W	120V



JC-12v 20w G4  
#41-532



JC-12v 35w G4  
#41-533



JCD-G8 120 Volt Xenon  
Bulb 20 watt #41-536

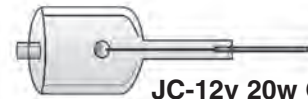

JCD-G8 120 Volt Xenon  
Bulb 10 watt #41-538

Replacement Bulb for #120v  
Halogen Light

### HALOGEN LIGHT

BULB	TYPE	FOR FIXTURE	WATTAGE	VOLTAGE
41-538	JCD-G8	120v Halogen Light pg 245	10W	120V
41-536	JCD-G8	120v Halogen Light pg 245	20W	120V
BULB	TYPE	FOR FIXTURE	WATTAGE	VOLTAGE
41-532	JC-G4	All Low Voltage Halogen Various Fixtures	20W	12V
41-533	JC-G4	All Low Voltage Halogen Various Fixtures	35W	12V

Kitchens

Doors

Kitchen  
Accessories

Hinges

Drawer  
Slides

Plywood  
Melamine

Veneer  
Edgebanding

Laminate

Solid  
Surface

Closets

Furniture  
Hardware

Pulls  
&  
Knobs

Lighting

Grommets

Locks,  
Lock  
Systems

Molding,  
Carvings

Tools

Adhesives  
Solvents  
Abrasives

Chemicals  
Staples  
Screws

## Replacement Bulbs



**41-541**

LUMENS	550
BULB LIFE	2,000 Hours
COLOR TEMP	2900
WATTAGE	50w
VOLTAGE	110v/60Hz
BEAM SPREAD	30 Degree
UV RATING	N/A
HEAT SINK	N/A

### PAR 20

- Bulb type: PAR20
- Line voltage 120V
- 50W
- Base type: Medium Base (E26/27)
- Super bright, Lumen output: 550lm
- Super white, Color temperature: 2800 k
- Average life: 2500 hours
- Overall length: 3-1/6"
- Overall diameter: 2-1/2"
- Color Temp. 2,900
- 30 Degree Beam
- Available: Flood



**41-543**

LUMENS	1,000
BULB LIFE	2,000 Hours
COLOR TEMP	3000
WATTAGE	75w
VOLTAGE	110v/60Hz
BEAM SPREAD	38 Degree
UV RATING	N/A
HEAT SINK	N/A

### PAR 30

- Bulb type: PAR30
- Line voltage 120V
- 75W
- Base type: Medium Base (E26/27)
- Super bright, Lumen output: 1000lm
- Super white, Color temperature: 2900 k
- Average life: 2500 hours
- Overall length: 3-5/8"
- Overall diameter: 3-3/4"
- Color Temp. 3,000
- 38 Degree Beam
- Available: Flood



**41-545**

LUMENS	1,300
BULB LIFE	2,000 Hours
COLOR TEMP	3000
WATTAGE	100w
VOLTAGE	110v/60Hz
BEAM SPREAD	38 Degree
UV RATING	N/A
HEAT SINK	N/A

### PAR 38

- Bulb type: PAR38
- Line voltage 120V
- 100W
- Base type: Medium Base (E26/27)
- Super bright, Lumen output: 1300lm
- Super white, Color temperature: 3000 k
- Average life: 2500 hours
- Overall length: 5-1/5"
- Overall diameter: 4-3/4"
- Color Temp. 3,000
- 38 Degree Beam
- Available: Flood

Kitchens

Doors

Kitchen  
Accessories

Hinges

Drawer  
Slides

Plywood  
Melamine

Veneer  
Edgebanding

Laminate

Solid  
Surface

Closets

Furniture  
Hardware

Pulls  
&  
Knobs

Lighting

Grommets

Locks,  
Lock  
Systems

Molding,  
Carvings

Tools

Adhesives  
Solvents  
Abrasives

Chemicals  
Staples  
Screws

## Power Supply & Accessories

Kitchens

Doors

- Safety Transformer
- All Connecting Wiring
- Low Voltage

Kitchen  
Accessories

Hinges

Drawer  
Slides

Plywood  
Melamine

Veneer  
Edgebanding

Laminate

Solid  
Surface

Closets

Furniture  
Hardware

Pulls  
&  
Knobs

Lighting



Item Number	Amp/mA Watts
<b>41-240</b>	150w

**Item Number 41-240**  
**ON / OFF TOUCH SWITCH**  
Switch includes direct wire connectivity.

Grommets

Locks,  
Lock  
Systems

Molding,  
Carvings

Tools

Adhesives  
Solvents  
Abrasives

Chemicals  
Staples  
Screws

### Push Switch

#### Features:

- On/off position
- 6" (15.24cm) cable
- 125V AC, 6A
- Single circuit sequence
- Works with every light except fluorescent
- For 120V primary connection

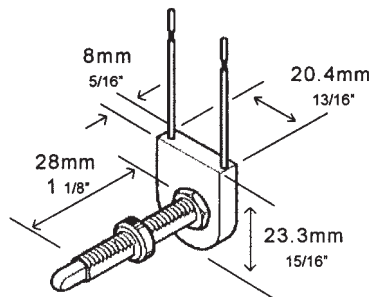

ORDER NUMBER	KNOB FINISH
<b>41-130</b>	Brass
<b>41-136</b>	Chrome

# Lighting

## Power Supply & Accessories

- Safety Transformer
- All Connecting Wiring
- Low Voltage

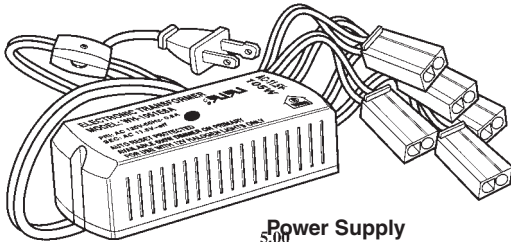

Power Supply  
Item No. **41-526**  
105w TRANSFORMER R.U.

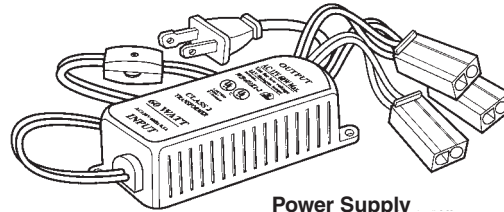

Power Supply  
Item No. **41-525**  
60w TRANSFORMER



Power Supply  
Item No. **41-454**



Item Number **41-514**  
Input: AC 100~240v  
Output: 30v 300 mA



Item Number **41-456**  
Input: AC 100~240v  
Output: 12v 1mA



Item Number	Input	Output	Amp/mA Watts
<b>41-525</b>	120v AC	12v AC	60w
<b>41-526</b>	120v AC	12v AC	105w
<b>41-456</b>	120v AC	12v DC	1 amp
<b>41-514</b>	100~240v AC	30v DC	300mA
<b>41-514 High Output Driver for LED Kits</b>			
<b>41-454</b>	100~240v AC	12v DC	3 amp
<b>41-510</b>	AC Junction Box		
<b>41-512</b>	DC Junction Box		



**AC -41-510**  
**DC -41-512**  
AC / DC Junction Box

- Kitchens
- Doors
- Kitchen Accessories
- Hinges
- Drawer Slides
- Plywood Melamine
- Veneer Edgebanding
- Laminate
- Solid Surface
- Closets
- Furniture Hardware
- Pulls & Knobs
- Lighting
- Grommets
- Locks, Lock Systems
- Molding, Carvings
- Tools
- Adhesives Solvents Abrasives
- Chemicals Staples Screws



# Lighting

## Power Supply & Accessories

Kitchens

Doors

Kitchen  
Accessories

Hinges

Drawer  
Slides



**41-982**  
White  
(Sold separately)



**41-980**  
10' Black  
(Sold separately)

Plywood  
Melamine

Veneer  
Edgebanding



**41-530**  
POLARIZED 10 FT.  
EXTENSION CORD  
FOR 110V



**41-981**  
10' White  
(Sold separately)

Laminate

Solid  
Surface

Closets

Furniture  
Hardware

Pulls  
&  
Knobs

Lighting

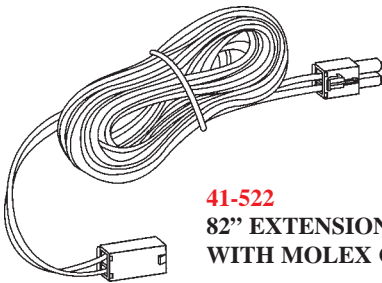

**41-522**  
82" EXTENSION  
WITH MOLEX CONNECTORS



**41-420**  
Black  
(Sold separately)

Grommets

Locks,  
Lock  
Systems

Molding,  
Carvings

Tools

15' Extension Cord Available With 5 Outlets

Adhesives  
Solvents  
Abrasives

Chemicals  
Staples  
Screws

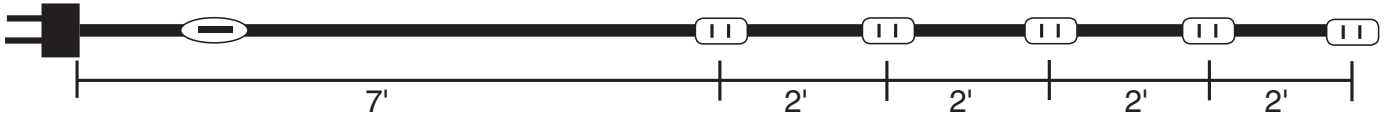

Order Number – **41-380**